

Danish Catch Quota Management trials - application and results



DTU Aqua Report No 256-2012

By Jørgen Dalskov, Hans Jakob Olesen,
Erik Møller, Søren P. Jensen, Mik Jensen,
Flemming Schultz and Mogens Schou

Fiskeriudvikling.dk

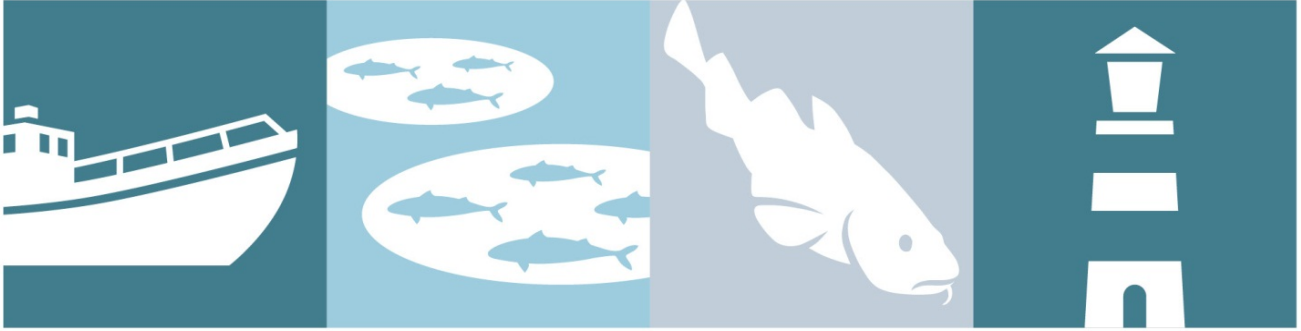

Danish Catch Quota Management trials – application and results

DTU Aqua report no. 256-2012

Jørgen Dalskov and Hans Jakob Olesen

Technical University of Denmark, National Institute of Aquatic Resources (DTU Aqua)

Erik Møller, Søren P. Jensen, Mik Jensen, Flemming Schultz and Mogens Schou

Danish AgriFish Agency

Denmark and The EU invest in sustainable fishing.

The Project is supported by the Ministry of Food, Agriculture and Fisheries and The EU

Ministry of Food,
Agriculture and Fisheries



The European
Fisheries
Fund

Table of Contents

1.	Executive summary	4
2	Background.....	5
3	Description of the trials	5
3.1	Objectives.....	5
3.2	Technical setup	6
3.3	Conditions for the 2010 and 2011 trials	7
3.4	Data handling and analyses.....	8
3.5	Control.....	8
4	Result of the trials	8
4.1	Fishing effort and geographical areas	8
4.2	Data collection.....	8
4.2.1	Logbook data	8
4.2.2	Sensor data	9
4.2.3	CCTV data	11
4.3	Discard estimates.....	11
4.4	Control.....	12
4.5	Catch composition of CQM vessels compared to non CQM vessels.....	13
4.6	Geographical distribution	17
4.7	Costs of control	20
4.8	Perspectives – seagoing inspections with CQM.....	21
5	Discussion.....	23
5.1	Reliability.....	23
5.2	Sanctions.....	24
5.3	Acceptance by the industry.....	24
5.4	Lessons learned and future perspectives	25
5.5.	Scope of result based management	26
6	Acknowledgement	28
7	References.....	28

1. Executive summary

Catch Quota Management (CQM) including full documentation has been on trial in Danish fisheries in the period 2010 to 2012. The trial aimed at testing whether CQM could provide a reliable accounting for all catches of cod, give better scientific data and encourage fishermen to fish more selectively and reduce accidental catches. The main feature of the trial is that all catches count against the vessel quota and that the fishing vessels are monitored from port to port using sensors and CCTV technology. The trial is a continuation of trials conducted since 2008 and it has been coordinated with similar trials in the UK and Germany.

22 vessels fishing in the North Sea, the Skagerrak and the Baltic Sea participated in the 2011 trial. Like in the previous trials the main focus has been on cod (*Gadus morhua*). Participating vessels were allocated an extra cod quota reflecting that the participating vessels counted all cod caught against their allocated quota including undersized fish that were discarded according to EU regulations. Exceptions for the days-at-sea restrictions were given because the shift from landings quota to catch quota was considered sufficient in limiting the outtake of cod to the amount intended.

The Remote Electronic Monitoring (REM) system has collected sensor data and images throughout the trial period and according to the vessel electronic-logbooks the vessels were at sea for app. 80,000 hours, carried out app. 1,114 fishing trips and conducted app. 9,800 fishing operations during the project period.

The main findings of the trial were the following:

- CQM with a full documentation is a feasible management to ensure that quotas can actually be administered with an absolute limit, so that catch limits becomes an exact expression of the set fishing mortality.
- The REM system can be applied on almost all types of vessels. Modification to vessel deck setups may be required in some cases.
- The REM system has proven its technical reliability.
- Inspection at sea by inspection vessels is not an efficient tool against discarding and it is in any event more costly than inspection of REM results.
- It is important that the fishermen are given information and guidance. The quality of the detailed recordings declined over time for some fishermen. Feedback may ensure the fishermen perception of full documentation as an integrated part of his business.
- In general, the industry has accepted having REM installed on board their vessels. There has been no negative feedback on the issue of having cameras recording the vessels working areas. Most of the fishermen are of the opinion that it is important to show what they are doing and what they are catching. In support of CQM with full documentation they at the same time underline the need to simplify and remove micro management.
- It could be considered whether a score card system or system to graduate how accurate the skipper/crew comply with the terms and conditions for a CQM system. CQM is a benefit for the fisherman and if he is not able to take sufficient responsibility for his documentation some of the benefits such as the quota premium and the removal of control rules could be annulled.

In addition to the CQM management trial Denmark conducted a scientific trial with full documentation of small gillnetters' catches of marine mammals. The trial is reported as "Fully documented fishery on small gillnetters 2012" at www.fvm.dk/yieldoffish.

2 Background

In the present Common Fisheries Policy (CFP) of the European Union a central measure is the limitation of catches in form of total allowed catches (TAC). TAC is defined as the quantity that can be taken and landed from each stock each year and the European Council decides each year on TACs for the individual fish or shellfish stocks and the allocation of the TACs among Member States.

In 2008 the Danish Government suggested that the utilization of the marine resources in the EU in the revised CFP should follow a result based approach with the requirement that the fisherman accounts for his total removal of fish from the resource rather than the landed catches.

By introducing full accountability through catch quotas instead of landing quotas the fisherman's incentive to optimize the value of his catch by discarding less valuable fish would be substituted by his incentive to use selective fishing methods to optimize the value of his total removals from the stocks. To achieve this objective the fisherman should receive increased quotas "catch quotas" to reflect that all fish is accounted for. At the same time he should be given the freedom of choice of method in conducting his fishery in order for him to make his own methods work for the best result. An incentive driven management system (Pasco et al. 2010) can have a positive effect on the will to live up to terms and conditions of a management system.

The present CFP with its quota and effort restrictions, high-grading ban and other restrictions contribute to a complex management system with a considerable incentive or obligation to discard catches. A catch quota management system with a fully documented fishery gives assurances that quotas can actually be administered with an absolute limit, so that catch limits becomes an exact expression of the set fishing mortality.

In order to test whether a Catch Quota Management (CQM) system could work and whether a full documentation of the fisheries could be made by the use of electronic monitoring systems a scientific trial was carried out successfully in 2008-2009 (Dalskov et al. 2009). The 2011 trial is similar to the 2010 trial (Dalskov et al. 2010) and mainly focused in a concrete management and monitoring context where the purpose of the projects was to assess the catch-quota system's workability in a fisheries management environment and its potential to account for all catches, reduce discards, provide better scientific data and encourage fishermen to fish more selectively through catch-quotas using sensor and camera technology.

"Fully documented fishery" entails detailed recordings in the logbook and the use of electronic monitoring systems where various sensors and CCTV cameras are recording fishing events and catch handling operations. When using sensor recordings and video footage, it is possible retrospectively to verify the electronic logbook recordings.

In the case of a management where it is allowed to discard fish it is necessary to establish procedures that ensure that the control may effectively assess the amount of discarded fish. In case of a discard ban full documentation must ensure that fish is not discarded. The precise weighing may then take place ashore.

3 Description of the trials

3.1 Objectives

The main objective of the projects was to assess CQM as a management with full catch accountability. Documenting and counting all catches is a precondition for precise advice and precise outtake of stocks and thereby fundamental to a policy based on MSY utilisation and a landing obligation.

Furthermore, the trial aimed at assessing the hypothesis that CQM will incentivize fishermen to fish more selectively, reduce accidental catches and thereby optimizing their economic gain as well as the ecological sustainability in the fishery.

3.2 Technical setup

When the first trials started in 2008 it was attempted to recruit vessels in the Western and Eastern Baltic, Kattegat, Skagerrak and the North Sea. It was also the aim to recruit vessels both smaller and larger than 18 meters, and vessels using different kind of gears such as trawl and gillnets. In the 2008-2009 trials 6 vessels signed in (one gillnetter, one Danish seiner and 4 trawlers), in 2010 a total of 7 vessels took part in the trial (all demersal trawlers) and in the 2011 trial 22 vessels joined in (14 trawlers, 6 Danish seiners and 2 long-liners).

Archipelago Marine Research Ltd. (Archipelago), Victoria, BC, Canada who has developed and deployed video based remote electronic monitoring (REM) on a variety of gear and vessel types (McElderry et al., 2005; 2006; 2008) was chosen by DTU Aqua who decided to use this REM system for the scientific pilot project carried out in 2008-2009 (Dalskov & Kindt-Larsen, 2009). The same system was used during the 2010 CQM trial (Dalskov, Håkansson & Olesen, 2011) and again in the 2011 trial.

The system comprises a GPS, hydraulic pressure transducer, a photoelectric drum rotation (winch) sensor (Figure 1) and four television (CCTV) cameras providing an overhead view of the aft deck and closer views of the fish handling areas and discard chute areas for catch identification. Sensors and cameras were connected to a control box located in the wheelhouse. The control box consists of a computer that monitored sensor status and activated image recording.

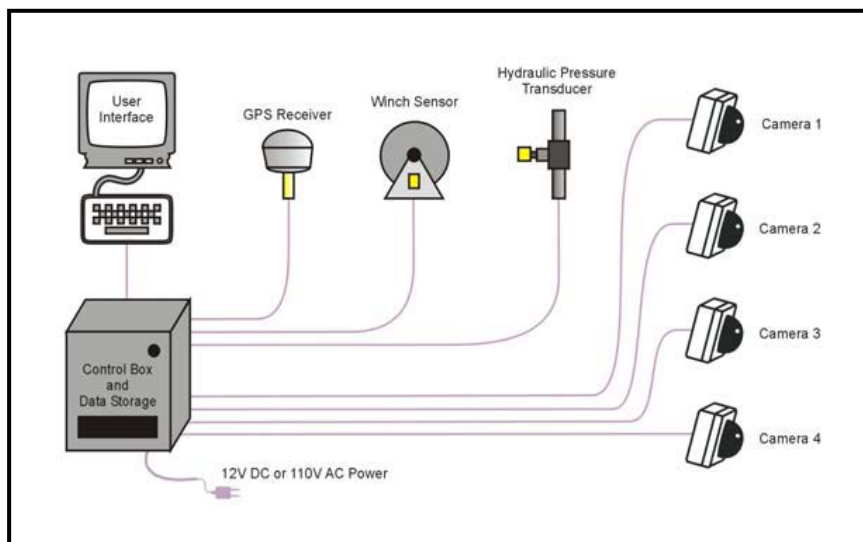

Figure 1. Schematic diagram of the electronic monitoring system, which can record sensor data and video images from up to four cameras per vessel.

The control box contained data storage capability for about 30 days of vessel fishing activity, and the computer was set to collect and store sensor data (GPS, hydraulic pressure and drum rotation). REM sensor data and image recording were recorded continuously while the REM system was powered which, in principle, was constantly during the entire fishing trip (port to port). While in port no recordings of data were made.

Reports on the outcome of the trials in 2008-2009 and in 2010 can be found as well as similar UK reports at: www.fvm.dk/yieldoffish.

The lessons learned and the main outcomes of all the trials are presented below with a main focus on the 2010 and 2011 trials.

3.3 Conditions for the 2010 and 2011 trials

The obligations for the vessels participating in the trials were specified in detail and the requirements to be met included Remote Electronic Monitoring (REM) equipment to be installed on the vessels, the vessels deck-arrangement, the processing of catches of cod and the reporting of catches. A vessel participating in the trials had to cease fishing with a gear for which cod was recognized as a target species when its quota for cod had been exhausted or, alternatively, obtain additional quota from the transferable quota system. This follows from the basic principle of CQM that all catches must be covered and counted against the quota.

Equipment requirements:

- The vessel must be equipped with a REM system which consists of a control box, a hydraulic pressure sensor, a rotation sensor, a GPS and an adequate number of cameras.
- The REM must be turned on before the vessel leaves port and should not be turned off before the vessel is moored at port.
- The vessel master must use the REM according to the guidelines for the system.
- The vessel must be equipped with a functioning VMS system.
- The vessel must be equipped with a functioning electronic logbook.
- The vessel must fill in the electronic logbook haul by haul and information must be sent to the Danish AgriFish Agency as soon as the processing of the catch is finished.

Requirements for vessel design:

- The vessel must be designed in a way that makes it possible to install a camera that is able to cover the area where the vessel is setting and hauling the gear.
- The vessel's working deck must be designed in a way that makes it possible to cover the whole working deck and the cargo hatches with an adequate number of cameras.
- Discard of fish must only take place via conveyor belt and hatches that can be monitored by a camera.

Requirements for catch processing:

- All cod above and below the minimum landing size must be separated from the catch. Cod below the minimum landing size must be discarded after weighing and after display for 30 seconds in front of a camera.
- Cod above the minimum size must not be discarded.
- Both the weight of cod above and below the minimum size should be registered haul by haul.
- Catches of fish restricted by a quota and above the minimum size must not be discarded. If the vessel does not have a vessel quota of a particular species, it must lease it or obtain it from other vessels participating in a quota pool.

Reporting requirements:

- The position of setting and hauling of gear must be recorded haul by haul and registered in the electronic logbook.
- The amount of cod that is kept on board and the amount of cod that is discarded must be recorded in the electronic logbook.
- The recording of other species must be done according to the normal procedure, haul by haul, and also the weight of the total discard must be recorded.
- Any problem with or breakdown of the VMS, REM or electronic logbook must immediately be reported to the Danish AgriFish Agency.

The installation of the REM-system including the placing of the cameras was completed under the guidance of DTU Aqua and the Danish AgriFish Agency was subsequently inspecting the installation for formal approval.

In addition to the above obligations the master of the vessel should comply with the following conditions:

- Perform a daily functionality test of the REM system
- clean the camera lenses whenever needed
- avoid blocking the camera views
- ensure adequate free capacity on the hard disk for the fishing trip concerned.

3.4 Data handling and analyses

The sensor and image data was stored on the REM hard disk drives. Danish AgriFish Agency staff collected the hard drives and subsequently the sensor data and video footage was stored on a server. All sensor data and selected video footage were interpreted using computer software developed by Archipelago Marine Research Ltd.

The purpose of sensor data interpretation was to determine the spatial and temporal parameters for start and end of each fishing trip and each fishing event. The key vessel activities including transit, gear setting, and gear retrieval were identified and compared with the logbook recordings.

The video footage was used to verify whether discards of cod had taken place without being recorded in the logbook.

The result of the analyses of the sensor and video footage was stored for further analyses by DTU Aqua.

3.5 Control

The main aim of the verification of the recordings in the logbook documenting catch handling and reviewing the discard pattern was to verify whether discards of cod were correctly monitored and recorded by the crew. The secondary aim of image interpretation was to examine and assess the amount of fish caught for comparison with the catch amount recorded by the fisherman.

4 Result of the trials

4.1 Fishing effort and geographical areas

In the trial carried out in 2010 a total of 7 vessels participated (all demersal trawlers) primarily fishing in the North Sea and secondly in the Skagerrak. Some of the vessels conducted a limited fishery in the Baltic Sea.

The 2011 trial was an upscale of the 2010 trial and 22 vessels joined in (14 trawlers, 6 Danish seiners and 2 long-liners). As for the 2010 trial the fishery was mainly carried out in the North Sea and the Skagerrak. Three vessels did carry out some fishing in the Baltic Sea.

4.2 Data collection

4.2.1 Logbook data

For each individual fishing operation the fisherman had to record the following information: Date, time and position of setting the gear, time and position of hauling the gear, total catch in weight, weight of the retained part of the catch by species, total weight of discarded cod and weight of

discard of other species. All vessels were equipped with electronic logbook systems and logbook data were transmitted daily to the Danish AgriFish Agency.

4.2.2 Sensor data

The data from the vessels participating in the Danish CQM trials in 2010 and 2011 origins from more than 302 and 1,114 trips respectively which together constitute more than 100.000 hours at sea (Table 1).

Table 1. Data collected during the CQM trials in 2010 and 2011

CQM trial	2010	2011
No. Vessels	7	22
No. Trips	302	1114
Time at sea (hrs.)	20677	80166
No. Hauls	2973	9824
Fishing time (hrs.)	16289	44478
Time gaps in Video (hrs.)	558	182
Time gaps (%)	2,7	0,2
No. Hauls image analysed	249	2177

More than 60.000 hours of fishing have been carried out during the two trials. The time gaps in the data collected with the REM systems have been reduced from 2.7% in 2010 to 0.2% in 2011. Time gaps are the time where the systems should have been recording but did not. The reduction in time gaps was most likely a combination of the fishermen getting used to the REM systems and therefore maintaining those better and increased skills by the people installing and servicing the REM systems. Some severe time gaps have occurred for one vessel due to the lack of space on the hard disk drive while fishing in the Baltic Sea. This type of error was not a system failure but was related to a malfunctioning land based operation combined with the lack of attention by the master of the vessel. The relative increase in images analysed was due to an optimized analysing process together with an increased routine by the image observers.

One of the main objectives was to test whether REM system data could be used to verify the fisherman's logbook recordings. By analysing the sensor data it was possible to compare accuracy of the date, time and position of each fishing event with the information the fisherman has recorded in his electronic logbook (E-log) and with the sensor data collected by the REM system. It should be mentioned that the data from the two long-liners is not included in the analysis shown in table 2. When using the REM system's GPS data in combination with the hydraulic pressure data it was possible to determine the exact date, time and position for shooting the gear and the retrieving of gear. Table 2 shows the difference in time for shooting the gear recorded in the fisherman's logbook with the time determined from the REM system data for 7,842 fishing events. In 66 % of the events the differences are less than 15 minutes which can be regarded as acceptable. It leaves, however, room for improvement.

Table 2. The mismatch in time between the REM system and the E-log in percentage for different time spans.

Vessel ID	Vessel Type*	<15min	15-30min	30-45min	45-60min	>60min	n
0	T	85	1	4	1	9	621
1	T	91	3	0	2	3	241
2	DS	79	10	2	1	8	256
3	DS	1	3	3	9	84	225
4	T	94	2	0	1	3	492
5	T	37	22	10	9	23	222
6	DS	67	18	4	1	10	485
7	T	89	2	2	2	5	574
8	T	63	19	2	3	13	344
9	T	54	12	9	6	19	286
10	T	86	2	3	1	8	517
11	DS	53	14	3	5	25	238
12	T	85	5	0	0	9	213
13	T	85	2	6	2	4	427
14	DS	34	21	3	2	39	201
15	T	90	1	1	2	6	562
16	T	56	5	9	2	29	348
17	T	88	2	2	1	7	1038
18	DS	15	11	0	8	66	213
19	T	40	3	9	10	38	339
Mean		66	7	4	3	20	7842

* Vessel type: T = trawler and DS = Danish Seine

As seen in table 2 Danish seiners have a lower accuracy than the trawlers which may be due to inadequate definition of haul start and haul end. The definition of haul start and haul end was more precisely defined for trawlers. If the analysis were made only for the trawlers the accuracy of less than 15 minutes difference between the recordings in the REM system and the fisherman's recording would be 75 %. Training of the fishermen and improvement of the features in the e-logbook will without doubt improve the accuracy.

The same evaluation was made with respect to the GPS position for a fishing event (table 3). As can be seen in the table the major part of the comparisons falls within 0.5 nm (average = 65 %). This is however not a high enough percentage to feel comfortable with the preciseness of the GPS positions noted by the fisherman. More than 30 % are more than 0.5nm off and 15 % are more than 1nm off compared to the REM system. The mismatches are not related to a few vessels only. In fact only a few vessels seem to be using the E-log with high accuracy. A more precise definition of haul start and haul end as well as training of the fishermen will improve the accuracy of the fishermen's logbook recordings. An E-log software that is adjusted to meet the purpose will also have a positive effect on the accuracy.

Table 3. The mismatch in GPS positions for fishing operations between the REM system and the E-log in percentage for different distances.

Vessel ID	Vessel type	< 0.5nm	0.5 - 1.0nm	> 1.0nm	n
0	T	39	44	17	610
1	T	42	45	12	238
2	DS	47	51	2	237
3	DS	94	5	1	223
4	T	76	21	3	487
5	T	79	17	4	210
6	DS	95	3	2	458
7	T	53	35	12	565
8	T	57	29	14	318
9	T	61	22	16	246
10	T	93	5	3	480
11	DS	97	0	2	232
12	T	83	13	5	208
13	T	45	25	30	401
14	DS	74	13	13	204
15	T	50	32	19	544
16	T	43	43	14	278
17	T	53	37	10	1006
18	DS	68	11	20	231
19	T	42	14	44	326
mean		65	23	12	7502

During the trials the participating vessels have in the North Sea used primarily bottom trawl either as single or double, main mesh size 120 – 130mm. Danish seiners, mainly mesh size 120 – 130mm. Long liners use baited hooks. When fishing in the Skagerrak the CQM vessels have used the same gears as in the North Sea or mesh sizes 90 – 110mm.

4.2.3 CCTV data

For every fishing trip, on average 10 % of the fishing events (hauls) with a minimum of one was selected for review. The image data was reviewed from the haul was taken on board to the end of the catch handling process where the catch was stowed away. The estimated discards of both cod and other species were recorded as well as eventual irregularities such as high-grading. The volume of discards estimated from the video footage was compared with the discard volume recorded by the fisherman in the logbook.

The CCTV footage was considered reliable for vessels with a size and design of the fish handling area that is easily monitored by the cameras. Smaller vessels may in some cases have blind angles which could be tackled by installing additional cameras. The latest version of the Archipelago REM 4.5 systems can handle 8 cameras and the hard drives data storage capacity is 1 TB, therefore, storage capacity problems is not an issue.

The output from the data analysis carried out by the Danish AgriFish Agency was further analysed by DTU Aqua.

4.3 Discard estimates

The vessels in the CQM project had to retain and land all fish above the minimum landing size according to the EU regulation. For most species the price per kg increases with fish size and vessels may benefit from only retaining large fish and discard small ones. This type of illegal discard is known as “high grading”.

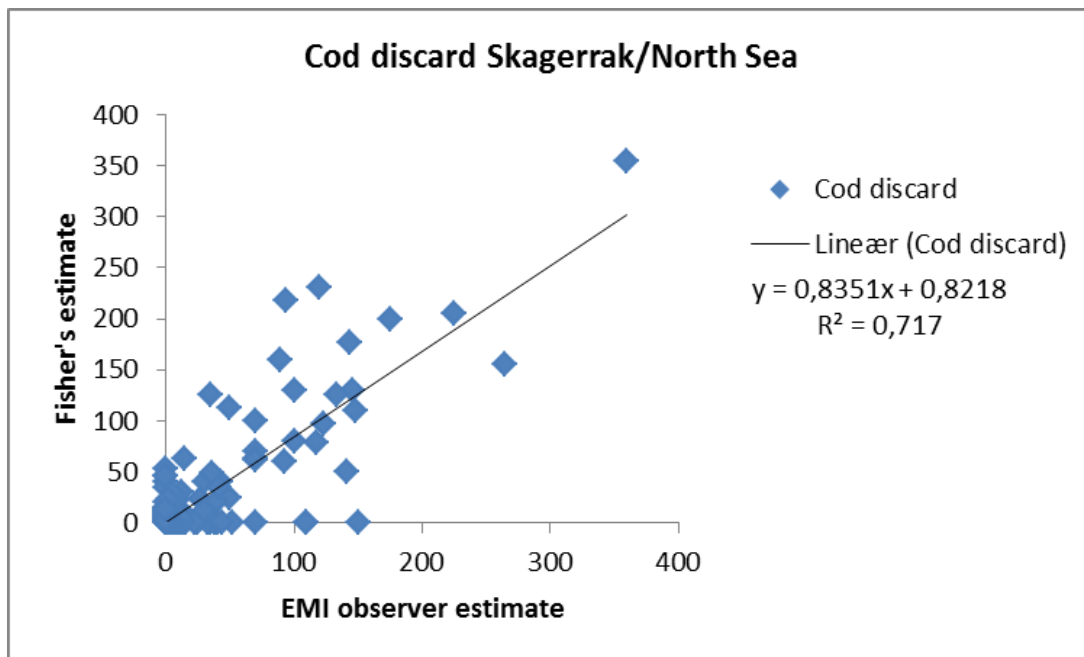

Figure 1. The relationship between the estimates from observers and fishermen of discard of cod from CQM vessels in 2011, $n = 727$. The slope of the linear equation is 0.835 which being close to 1 indicates that there was a good coherency between the fishermen's and the observer's estimate of discard. The fishermen's estimates of discard were in general smaller than the observer's.

In general there was a good consistency between the fishermen's recording and the image data. Though improvement can be made especially if the area around the discard chute could be adjusted with regard to optimal video footage.

4.4 Control

When reviewing the video footage non-compliance with the basic requirements of the TAC-Regulation the additional terms and conditions for the vessels participating in the trials was observed.

In 2011 cases of non-compliance was detected in relation to the following terms and conditions:

- The obligation to register the total landing of cod including discards
- The obligation to perform a daily test of the REM system
- The obligation to ensure the cameras' clear view of the fishing operations
- The obligation to ensure available space on the hard disks
- The obligation to register vessel position, date and time of each fishing operation
- The obligation to separate cod from the catch and weigh cod below the minimum landing size
- The obligation to discard from a camera monitored area of the conveyor belt
- The obligation to register catches haul by haul
- The obligation to register discards of cod as well as other discards

Two vessels were sanctioned due to violations of rules and procedures. The Danish AgriFish Agency applied the following sanctions:

- For one vessel the registration in the logbook was not performed correctly as the actual discard of cod was evidently much larger than the registered discard. However, a complete evaluation of the infringement did not lead to the vessel being excluded from the CQM. Instead, the vessel's discard was established at a higher level which led to a downwards

adjustment of the vessel's quota. The sanction was applied administratively and accepted by the fisherman.

- For the other vessel, apart from having the same problems as in the first case, the vessel continued fishing for 10 days fully aware of the fact that there was no available space on the REM system's hard disk. The combined infringements were considered serious and led to the vessel's exclusion from the CQM and the withdrawal of premiums. As a consequence the vessel was forced to lease additional quota from the transferable quota market in order to compensate for an otherwise case of overfishing.

4.5 Catch composition of CQM vessels compared to non CQM vessels

A comparison was made between CQM vessels and a group of vessels (reference vessels) fishing in the same areas with the same gear type and mesh size and the rest of the fishing fleet. The comparison was made time and area specific but also in a broader perspective to ensure that all the landings for the relevant reference vessels were covered i.e. the fishery in other ICES rectangles by the reference fleet should be considered in the data as this contributes to the total landing pattern for these vessels. Species and size composition come from the official landings data. Size composition was only analysed for cod and for commercial size grades. The data analyses have been separated into before and after the vessels have entered the CQM scheme.

The development in catch compositions for the CQM vessels was studied. To assess whether the CQM vessels changed fishing pattern a reference fleet was selected. When comparing the CQM vessels' catch composition with the catch composition of a reference fleet, only vessels using the same type of gear and mesh size range was included in the reference fleet. It was also important to compare the species composition of the landings made by the CQM vessels with the reference fleet to ensure that the fisheries for both fleets are targeting the same species. Examples of the catch composition for both participating and reference vessels are shown for the year prior to (2009) and after joining the CQM trial (2010 and 2011). All vessels are 18 – 24m total length. The species included was restricted to the most important common commercial species landed and the percentage was calculated as the total catch of these species in weight. In the North Sea the CQM vessels fishing with mesh size => 120mm have primarily targeted cod, plaice and saithe in all the years in their fishery (fig. 2). The same picture was seen for the reference fleet vessels. Both groups of vessels have increased their relative landings of plaice from 2009 to 2011. The CQM vessels have increased their landings of cod. The opposite tendency for cod is seen for the reference vessels. The landings of saithe decreased for the CQM vessels and have been steady for the reference vessels. The most dominant change in catch composition observed after entering the CQM trial was a larger percentage of cod in the landings for the CQM vessels, this species together with plaice being the most dominant following the onset of the trial probably as the vessels could land more cod instead of discarding cod .

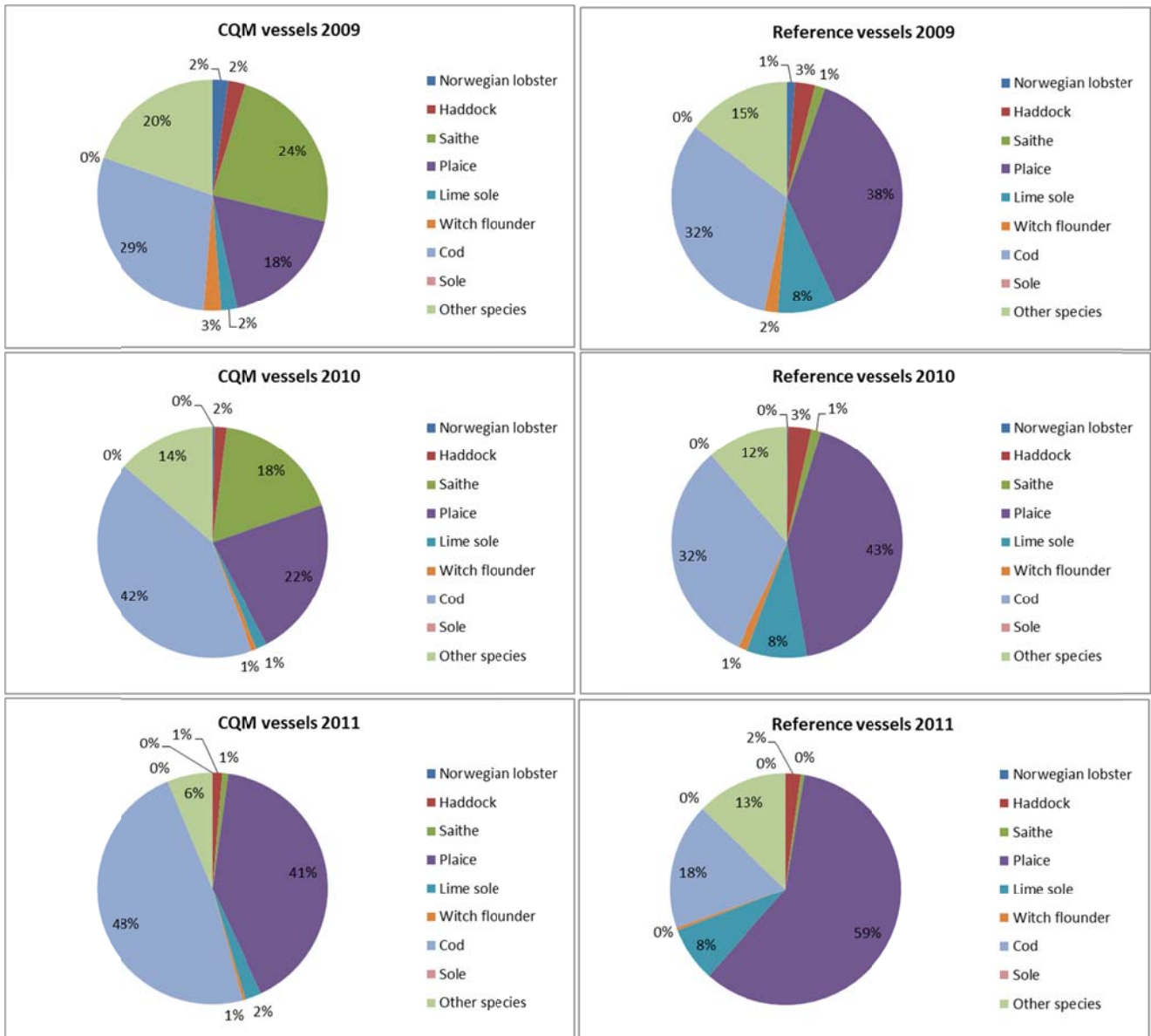

Figure 2. Catch composition for CQM and reference vessels (18 – 24 m length) in the North Sea fishing with mesh size >120 mm.

For Skagerrak the catch composition is shown for the same length and groups of vessels (CQM and reference vessels) (fig. 3). Here the catch composition for the CQM vessels changes opposite that seen in the North Sea with respect to the CQM vessels. The contribution of cod in the landings decreased from 45 % in 2009 to 12 % in 2011 for these vessels after entering the trial. The landings of plaice increased from 10 % in 2009 to 57 % in 2010 while saithe decreased in the landing volume. The catch composition for the reference fleet was quite steady throughout the period and only shows minor changes, i.e. a small increase in contribution of plaice in the landings from 2009 to 2010. The decline in relative cod landings observed for the CQM vessels was not seen for the reference vessels having 12 % of cod in their landings in 2009 and 14 % in 2011. The catch composition for both groups of vessels in Skagerrak was dominated by plaice making up around 60 % of the total landings.

No increase in cod landings for the CQM vessels from any of the waters were observed following the onset of the trial. The catch composition changes but this was mainly caused by fluctuating quotas on other important species, e.g. for plaice and saithe.

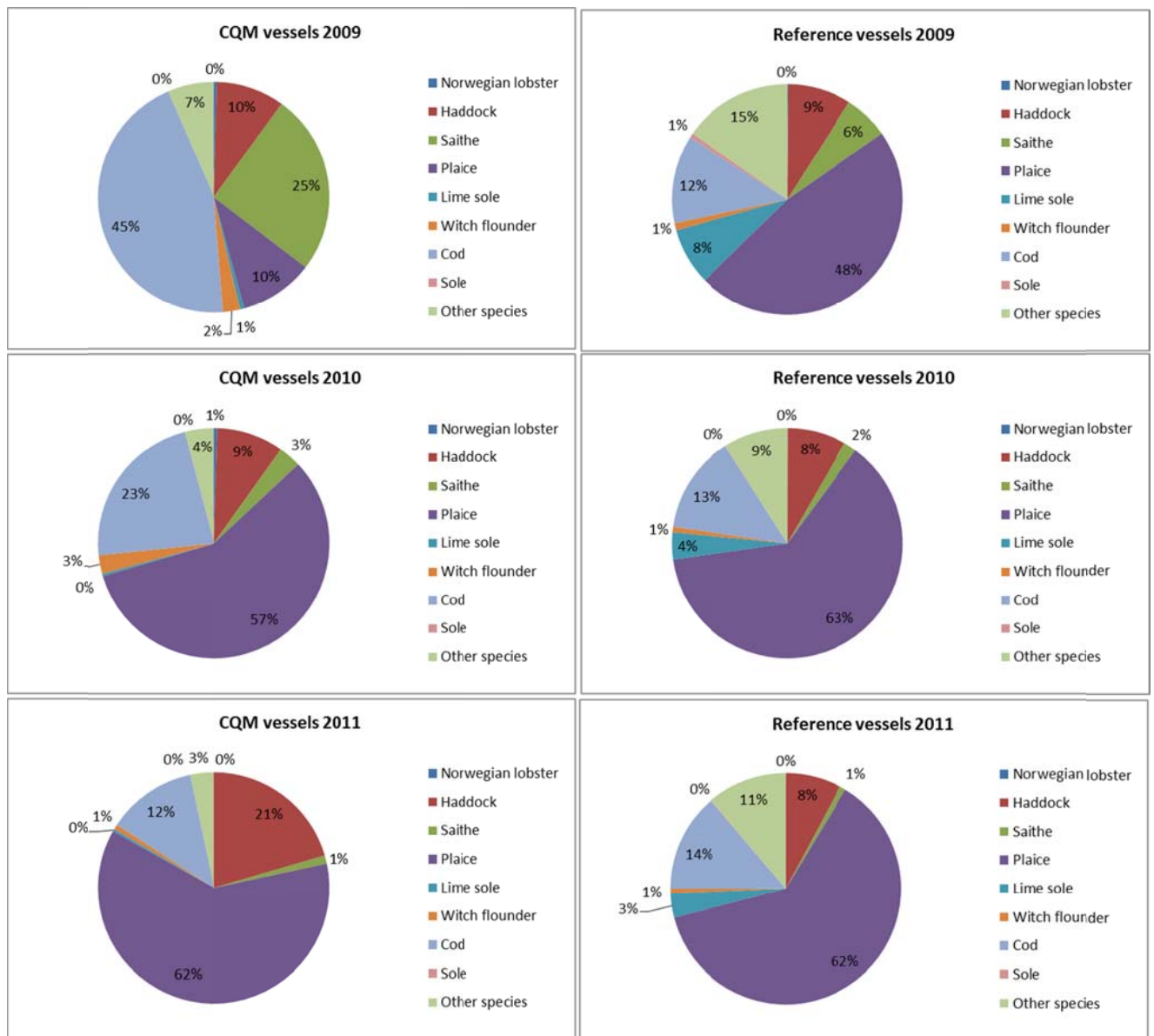

Figure 3. Catch composition for CQM and Reference vessels (18 – 24m length) in Skagerrak fishing with mesh size <120 mm.

The size grade composition for cod catches from the CQM vessels was compared with the reference fleet by comparing their respective landing patterns. The proportion of the smaller size grade (size grade 4 and 5) cod can be an indication of high-grading (discarding with the aim of increasing the value of the landings).

For the vessels fishing with ≥ 120 mm mesh size in the North Sea (fig. 4) the CQM vessels had 5 % size grade 5 cod in their landings in 2009 (before joining the CQM scheme) which rose to around 12 and 13 % in 2010 and 2011 respectively, both years with CQM. The reference fleet showed only a weak increase (1-2 %) in landings of size grade 5 cod during the same time span. For the size grade 4 only a slight increase in the landings is seen for both groups of vessels after the onset of the CQM trial.

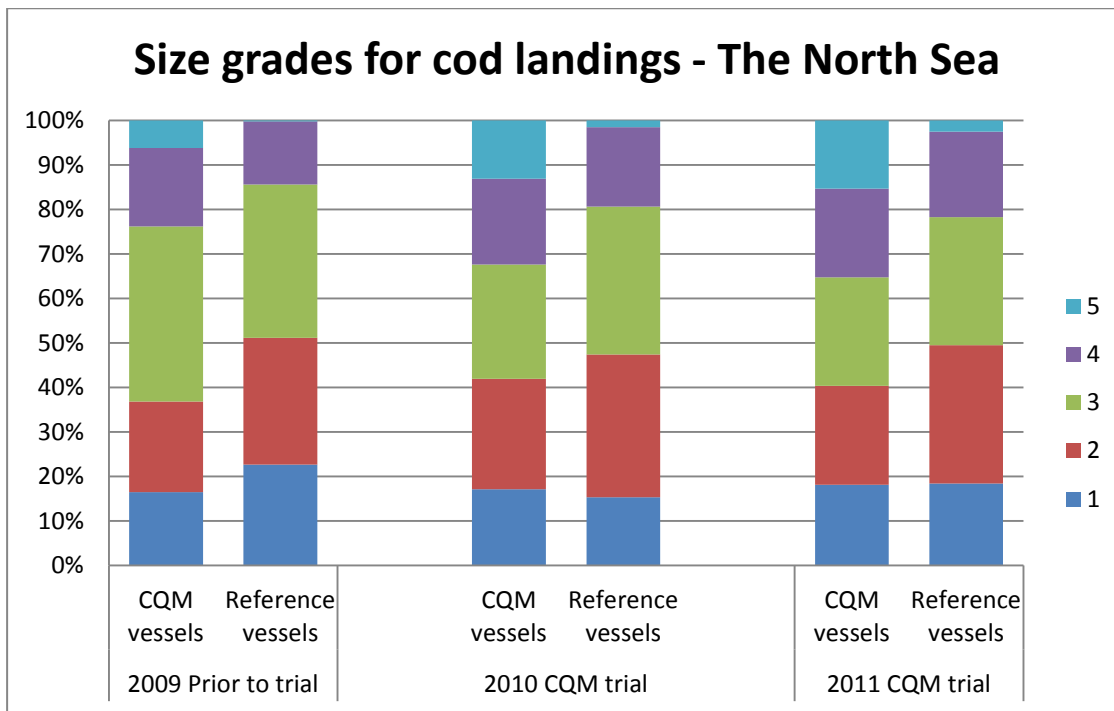

Figure 4. Cod landings from the North Sea for CQM and reference vessels. All vessels have been fishing with trawl or seine, mesh size ≥ 120 mm.

For the vessels fishing with ≥ 120 mm mesh size in Skagerrak (fig. 5) the CQM vessels had approx. 7 % size grade 5 cod in their landings in 2009 (before joining the CQM scheme) which after the CQM trial began rose to >20 % and 27 % in 2010 and 2011 respectively. The reference fleet increased its landings of size grade 5 cod (from 1-2 % to 8-10 %) during the same time period. For the size grade 4 a small increase was seen for the CQM vessels from 25 % (2009) to 30 % (2011) while the reference fleet during this period more than doubled the proportion of size grade 4 in the landings from 15 % (2009) to 35 % (2011).

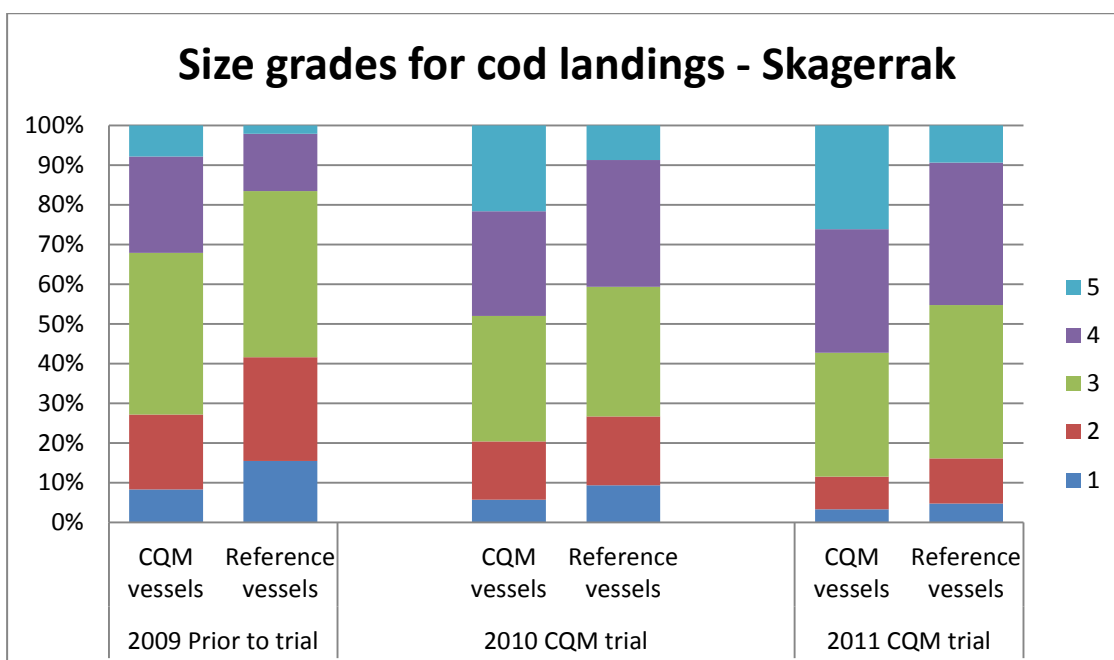

Figure 5. Cod landings from Skagerrak for CQM and reference vessels. All vessels have been fishing with trawl or seine, mesh size ≥ 120 mm.

Change in size grade distribution may be caused by several factors such as the species viability in relation to the set quota, change in prices per kg. per size grade (less differences between size grade 3 - 4 and especially between size grade 4 and 5) and change in selected fishing ground as most demersal fisheries are mixed fisheries and therefore catch opportunities of other species have to be taken into account. But as data used for the analysis was data for a large number of vessels it can be concluded that high grading takes place if fishing was not fully monitored and documented.

4.6 Geographical distribution

The geographical distribution of the CQM vessels prior to 2009 and after entering the CQM trial (2011) is shown in figure 6a-f together with the group of reference vessels. The comparison in geographical distribution is important to make sure that the reference fleet was fishing in same area as the CQM fleet prior to the CQM trial. The maps are based on VMS data. If any, only a small change towards a wider geographical distribution is observed for both vessel groups after joining the onset of the CQM trial. A comparison of CQM vessels with the fleet of reference vessels show that while the gravity of the CQM vessels effort mainly is in the Norwegian EEZ in the North Sea, the gravity of the effort for the other vessel group is in Skagerrak and the central eastern North Sea. The comparison between the two fleets shows that there in general is a good coherency between their respective geographical distribution patterns during fishing. Any change in geographical distribution caused by a change in skipper behaviour should be investigated on a much smaller geographical scale as this change in behaviour is often triggered by single events where small fish are encountered in the catches.

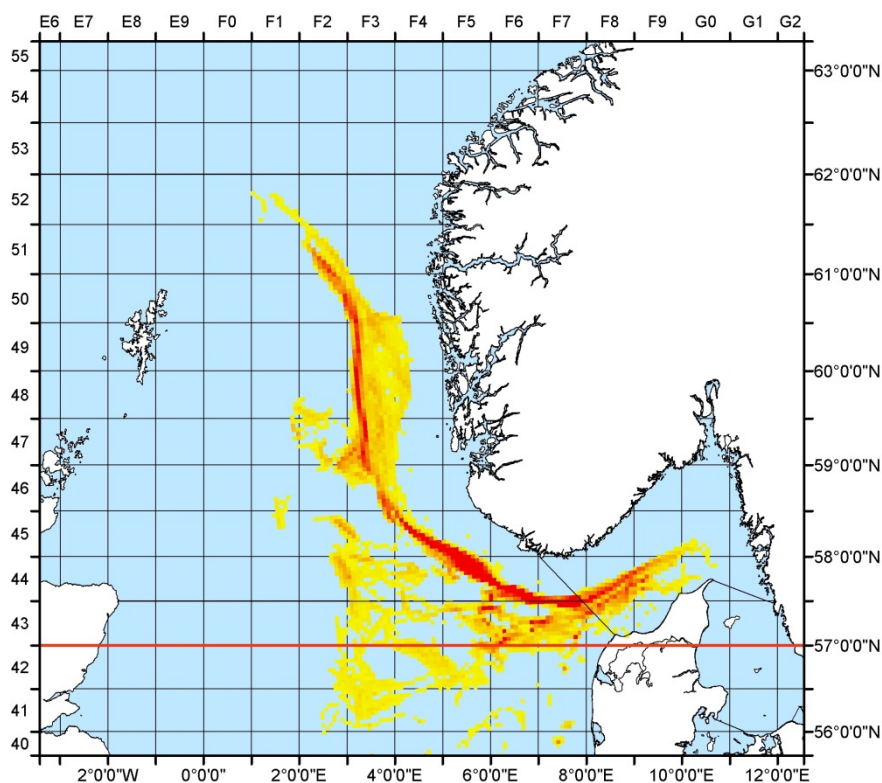

Figure 6a. VMS plot for the CQM vessels 2009 prior to the CQM trial. The red line indicates the southern border from where data was analysed. The majority of the fishery is along the Norwegian slope (red selection).

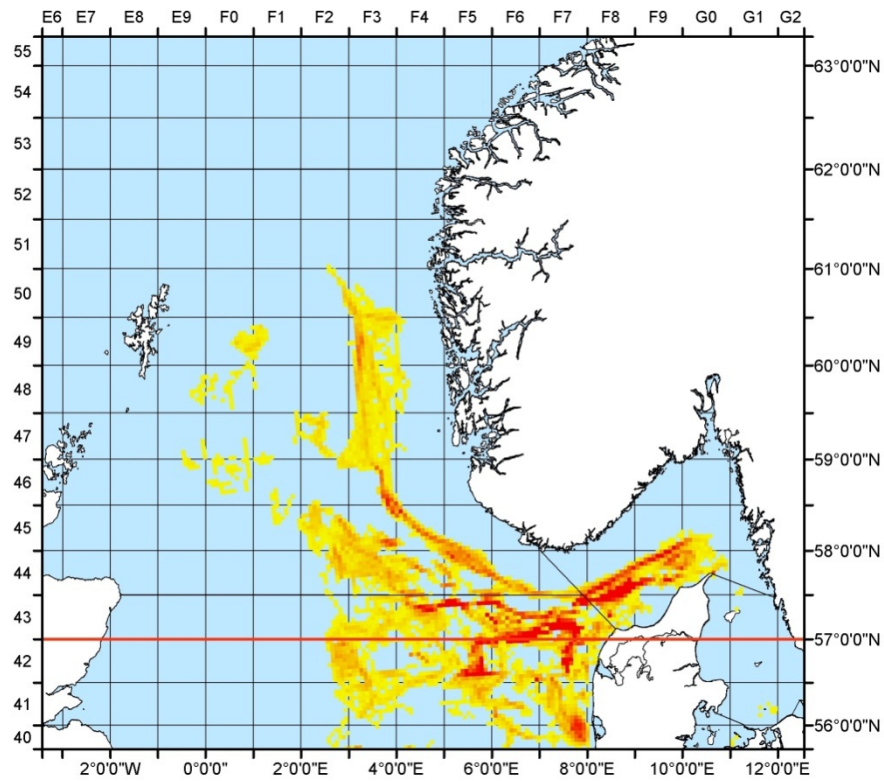

Figure 6b. VMS plot for the reference vessels 2009 prior to the CQM trial. The red line indicates the southern border from where data was analysed. The majority of the fishery is along the Norwegian slope and in general the North Eastern part of the Central North Sea (red selection).

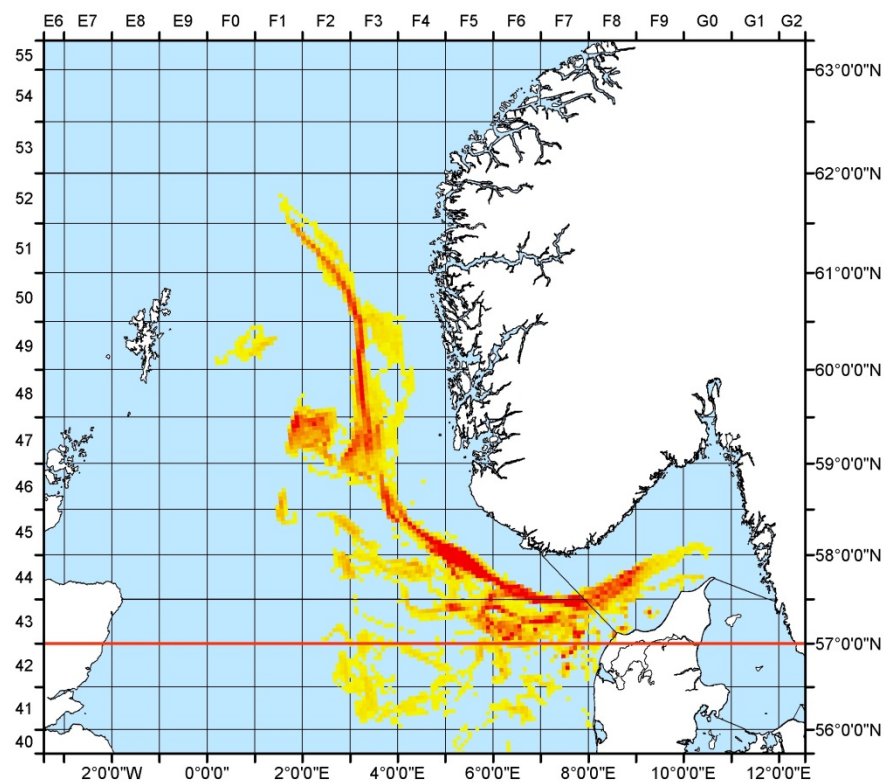

Figure 6c. VMS data for the CQM vessels 2010 after the start of the CQM trial. The red line indicates the southern border from where data was analysed. The majority of the fishery is similar to that prior to the start of the CQM trial.

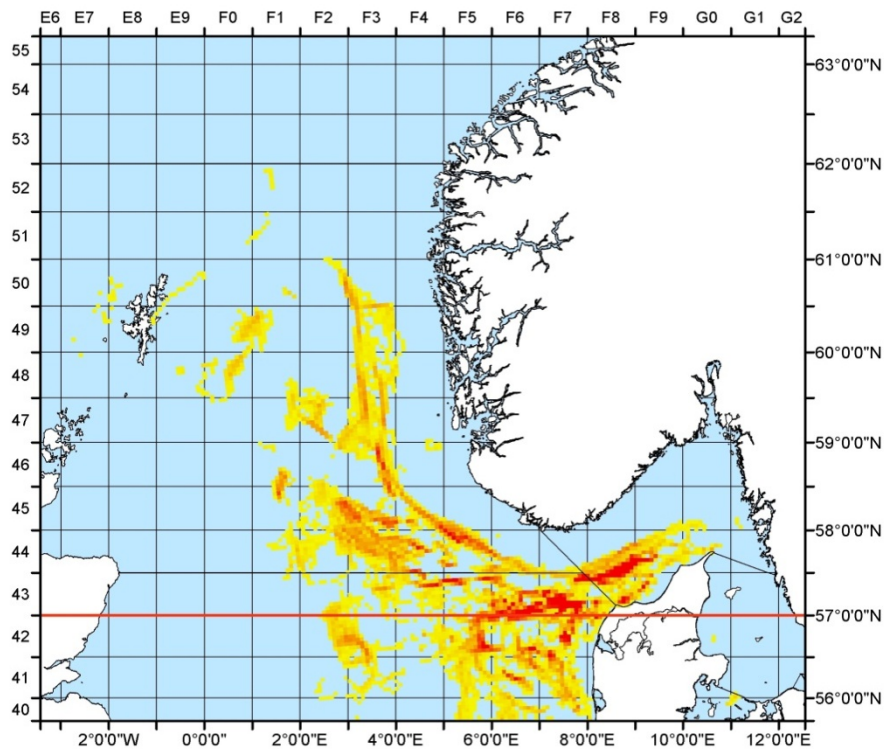

Figure 6d. VMS plot for the reference vessels 2010 after the onset of the CQM trial. The red line indicates the southern border from where data was analysed. The majority of the fishery is along the Norwegian slope and in general in the North Eastern part of the Central North Sea (red selection).

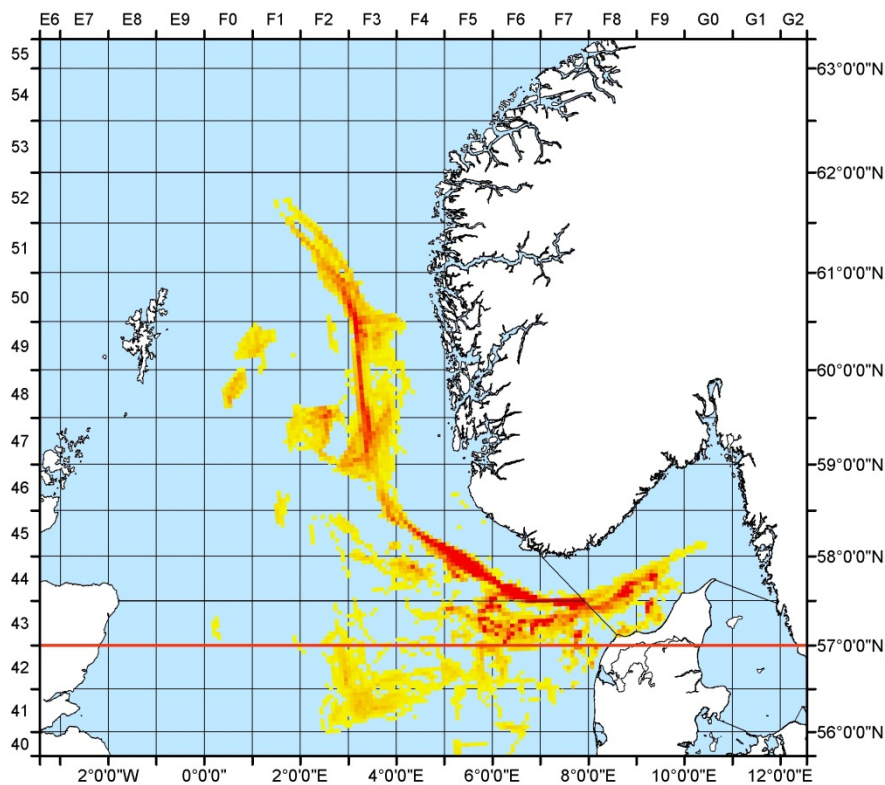

Figure 6e. VMS data for CQM vessels 2011 after the start of the CQM trial. The red line indicates the southern border from where data was analysed. The gravity of fishing is similar to that prior to the start of the CQM trial.

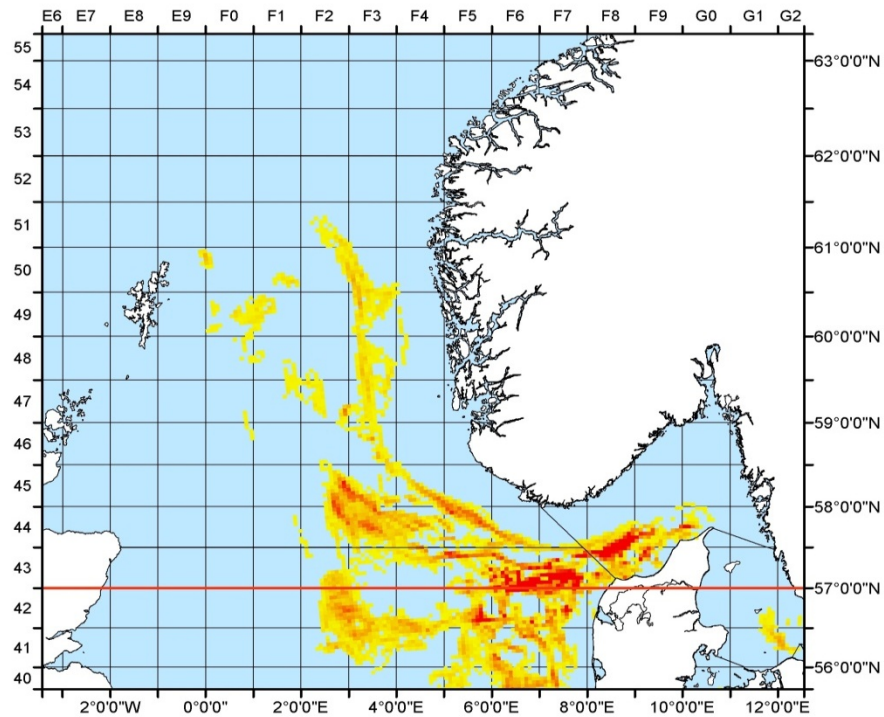

Figure 6f. VMS plot for the reference vessels 2011 after the onset of the CQM trial. The red line indicates the southern border from where data was analysed. The majority of the fishery is in the North Eastern part of the Central North Sea and Skagerrak (red selection).

4.7 Costs of control

In 2011 the Danish AgriFish Agency spent app. 3000 hours watching CCTV footage of fishing operations from the 22 participating vessels. On average 10 % of fishing voyages were monitored starting from the time the gear was hauled until the catch had been either stowed or discarded. The total expenses used for monitoring has been estimated to app. DKK 20,000 pr. vessel (app. € 2,700).

The costs of monitoring a complete discard ban is estimated at a somewhat lower level pr. fishing trip than in the existing project as images probably can be monitored at a higher speed. In the CQM the discard has to be estimated which requires a thorough monitoring and estimation (weight) of the discarded fish. Upon obtaining a certain level of routine it should also be possible to monitor more than one fishing operation at the time thus reducing the monitoring costs.

It is difficult to make a direct comparison with the existing resources used for inspection at sea as the latter is rarely used to monitor discard. The focus for inspection at sea is more on the gears used for fishing. Further, the costs of inspection at sea are proportional to the size of the inspection vessel as well as the size of the crew. There is, however, no doubt that inspection at sea by inspection vessels is more costly than inspection done by watching CCTV footage.

It would be relevant to develop a risk based control approach where each fisherman's history of complying with the terms and conditions for a fully documented fishery is taken into account. The better the fisherman complies with the rules, the less the fisherman should be targeted by the fisheries inspectors. Furthermore, an approach with constant interaction between the control authority and the fishermen where the outcome of quality checks of logbooks and REM data analysis from each fishing trip is reported back to the individual vessel master would also improve the level of compliance. It should be technically possible to conduct a number of quality checks without human

interference. It is considered that this constant interaction will ease the work for the master and maintain the level of focus needed for good data quality.

An alternative system where each logbook-check and REM system data-check report states whether the logbook records meet the data standards and, in instances of poor scores or inaccurate information on fishing times and locations, provides feedback to help fishermen improve their recording could be envisaged. If the results of the audit lie within predefined tolerances, the logbook record for that trip is deemed valid and becomes the official record. A score system could be set up where e.g. the full compliance gives a maximum score of ten, while the inaccurate recording of time and position for one to two fishing events gives a score of nine etc. If such a system is used the inaccurate recording from one trip could be accepted if the vessel's annual history of performance and compliance is generally acceptable.

If a specific fishing trip fails the audit and the vessel has a poor history of recording (see figure below), the results are investigated by a fishery inspector. Following a formal hearing of the fisherman, the fishery inspector may choose to use the logbook record as it stands, make adjustments to it or request an image analysis of additional fishing events.

The fishery inspector may also recommend that legal actions be taken against the vessel and fisherman.

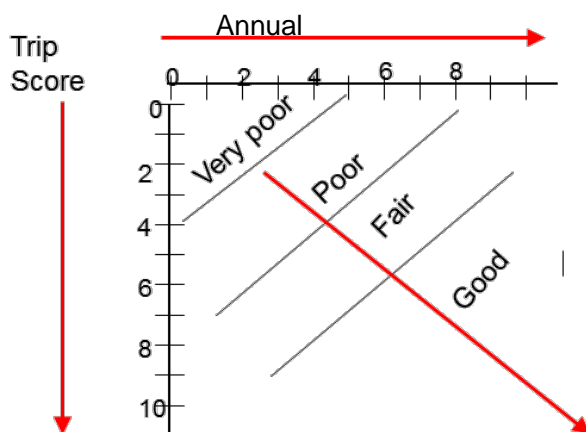

Other risk based control approaches where focus on the monitoring of CCTV footage of certain vessels or types of fisheries with a history of major discards could also be envisaged.

4.8 Perspectives – seagoing inspections with CQM

As part of the discussions relating to the transition from managing landing quotas to the landing of catch quotas it could be argued that certain management rules could be abolished and the level of inspection at sea could be reduced. No doubt, from a cost-efficiency point of view it would benefit the industry if the inspection and monitoring could be simplified as would be the case if certain management rules could be abolished.

On that background, The Danish AgriFish Agency has made an analysis of the relevant inspection and control tasks at sea undertaken by the inspection vessels that could possibly be reduced or abolished in case of a full implementation of a CQM regime.

The analysis is based on the background of different scenarios. The scenarios are, however, very broadly formulated and consequently it is necessary to operate under certain prerequisites. As a

result hereof the conclusions are not entirely unambiguous and further studies are needed in order to establish some more substantiated conclusions.

The following scenarios have been analysed:

- I. Full use of CQM: it is assumed that all Danish fishing vessels as well as foreign vessels fishing on the Danish sea territory are equipped with the REM-system, that all species are subject to a discard ban and that data is available to the coastal state.
- II. Partly use of CQM: It is assumed that the most significant part of both the Danish and the foreign fishing vessels are equipped with the REM system and that the regime encompasses the most important species.
- III. Fewer technical rules. It is assumed that there is no longer need for rules relating to gear dimensions, mesh sizes, selective devices, catch composition, the separation of catches, real-time closures etc. for vessels fishing under a CQM regime.

Under the abovementioned scenarios there appears to be room for changes in the following types of obligations:

- Territorial infringements: In theory it will be possible to monitor position and activities of a CQM-vessel. However, without inspection at sea it will be difficult to enforce sovereignty or inspection of wholly or partly closed areas. The intensity of seagoing inspection and control can be debated but the complete abolition will most likely lead to an increase in infringements often disguised under breakdowns of the REM-system. It would strengthen the inspection of CQM vessels if sensor data or CCTV footage could be transferred automatically during the fishing voyage.
- Arrests: If infringements can be documented by the use of REM-systems, boarding and arrest of the vessel could be avoided. The follow up can either take place in either the coastal state or the flag state. Enforcement of sanctions can however be weakened without bank guarantees. Vessels not subject to the CQM regime will remain subject to seagoing inspection and control.
- Licenses and permits: Control of fishing licenses and permits can be done administratively for Danish vessels. Licenses and permits held by foreign vessels should be subject to inspection via a website in the flag state.
- Technical rules: A CQM regime can't replace sea going inspection under the existing technical rules. A partly use of CQM will require seagoing inspections of vessels not subject to the CQM regime. The abolition of all technical rules should only apply to the CQM vessels. The control of hygiene remains a duty for the inspection vessels.
- Catch reporting: If a discard ban can be controlled by the REM system, only vessels not subject to the CQM regime will remain subject to inspection at sea. As long as the REM-system can't fully document the catches, there will remain a need for inspection at sea in relation to catch area reporting. With a partly use of a CQM regime there remains a need for inspecting catch areas for vessels not subject to CQM.
- VMS: VMS data should be subject to administrative control. The inspection vessels' role could be limited to the verification of VMS data.
- Notifications: All prior notifications from CQM vessels can be controlled administratively. All other vessels remain subject to the existing inspection procedures.

Conclusion:

Under the abovementioned assumptions it seems evident that inspection and control at sea could be reduced quite significantly under the full use of a CQM regime and under the prerequisite of a discard ban and that data from all vessels is available to the coastal state. Further explorations of the full potential of the CQM need to be conducted in order to reach a more substantiated view point.

5 Discussion

5.1 Reliability

The REM system has proven its reliability. The experiences obtained during this 2011 project and the outcome of the previous CQM projects have shown that the REM system can be applied on almost all types of vessels. Onboard some vessels some modification to vessel deck setups and interior catch handling flow in order to obtain appropriate image coverage for the full documentation processes may be required.

As seen in table 1 the time gap of 0.2 % shows that the REM system works very well.

It is very important that the fishermen are given information and guidance regarding the recording of the vessel activities such as the time of deployment and retrieval of gears. Experience from the trial has shown that the quality of the detailed recordings made by some of the fishermen declined over time. Therefore, constant feed back to the fishermen is essential and it should be stressed that this should be a fully integrated part of the programme.

During recording: The Danish CQM trial entails recordings from different fisheries and types of vessels which entail some variability in the quality of recordings.

- The position of the cameras on the vessels is of great importance to the quality of video recordings e.g. camera views and water on the dome.
- Different fisheries; when targeting certain species larger total catches can be expected making it difficult to distinguish between species during video data analysing due to too many fish on the conveyer belt.
- Time gaps in video recordings due to REM system failure. The system failures have been caused by a variety of reasons. Some being hardware or software related while others have been caused by inappropriate use on board the vessel.

During exchange and transport of hard disk drives (HDD):

- The exchanges of HDD have in a few occasions led to unintentional deletion of data. This was caused by incorrect HDD exchange. Human error which can be avoided by training of staff.
- HDD have been lost in the mail.
- Delay in HDD swapping forces the system to a halt in recording.

During upload and analyses: The data is being retrieved from the HDD and analysed using REM system specific software.

- During upload of the data from the HDD some failures on the HDD have been encountered. The defects have most likely occurred during transport as the HDD all were functional when being exchanged. All data on the erroneous HDD may be lost.
- During analysis the data is being processed by several different people which have the disadvantage of risk for errors when creating files e.g. data doublets. Human error which can be avoided by training of staff.

The performance of the REM system used has in general been good though some issues remain after several years of experience with the system. The drum/winch rotation sensors are not robust enough to withstand the harsh environment when placed on deck. The electric contacts in the control box drawer have been causing failure on boot up of control box when exchanging the HDD. This issue was solved in the new version (v 4.5) of the control box.

The most severe impact on the data quality occurs if complete HDD disappears when mailed by post. A loss of a complete HDD represents the loss of 20 – 30 days recording of video- and sensor data. This issue could be solved by uploading data to a server locally and subsequently transferred to the competent authority for analysis.

5.2 Sanctions

The commercial fishery is regulated by a vast set of Union rules as well as national rules. In order to abide to the principle of proportionality, there has to be a similar variation in the sanctions applied for the infringements of the various rules.

In this respect Denmark has over the years developed a firm sanctioning practice. Normally, the fine is set at one third of the catch value with a minimum of DKK 2,500. The fine is usually supplemented by the confiscation of the illegal catch and if relevant the illegal gear or gear used for illegal fishing.

This practice has the advantage of setting fines on the basis of the catch value instead of a fixed sum. Particularly serious infringements can be additionally sanctioned with the withdrawal of a vessel permit for a fixed period as well as a part of an individual vessel quota related to that period.

The discard of catches that can be legally landed (high-grading) has been banned for several years. A violation of a high-grading ban as well as other discard bans can be seen as similar to other types of illegal fisheries such as overfishing as basic conditions for the fishing activities are not complied with. The damage to the stock is also identical in case of illegal discard or overfishing. There is, however, a distinction as the fishing operation as such has been legal. Another distinction relates to the sanctioning as confiscation of the catch value and the fishing gear does not apply in cases with illegal discard. Hence, the sanctioning level is often lower in discard cases than in other cases of illegal fishing.

The main problem with illegal discard seen from a sanctioning perspective is the burden of proof which is much more difficult to lift without the use of CCTV.

The advantage of withdrawing fishing permits is the immediate effect on the vessel's fishing pattern. The signal to other fishermen is also clear. It should, however, be noted that the CCTV footage is often analysed weeks after the actual fishing operation which somewhat removes the immediate effect of the sanction.

In general, a rather transparent sanctioning system for CQM vessels would be beneficial as the vessel master in advance would know the consequences for not complying with the specific CQM terms and conditions for the trial. This could include the reduction of additional quota allocated to the vessel.

In case of minor infringements a smaller sanction can be applied, e.g. a temporary exclusion from the CQM including a partly deduction of the premium.

5.3 Acceptance by the industry

In general the industry has accepted having REM installed on board their vessels. The perception of the industry is that if the CQM system including having REM systems installed can revoke some of the very detailed regulations it would be a benefit to all. If on the other hand the REM system is just

an administrative burden and additional cost to the present management system the industry will be strongly opposed.

There has been no negative feedback on the issue of having cameras recording the vessels working areas. Some fishermen have expressed that it only takes one or two days before the presence of the cameras have been forgotten.

Most of the fishermen are of the opinion that it is very important to show what they are doing and what they are catching. The growing pressure from the NGO's has strengthened this approach.

5.4 Lessons learned and future perspectives

The different stakeholders in CQM will have different needs regarding data requirement and handling. From a control perspective e.g. with respect to a potential discard ban, documentation by cameras will be sufficient while the data requirement for use in science would need recordings of several other variables.

In CQM the data requirements needed for reviewing the fishermen's recording could be listed as follows:

- reporting in the logbook should be made on a haul by haul basis,
- all catches should be reported down to the kilo and catch and discard (amount)/species/haul should be electronically available.
- GPS, hydraulic and rotations sensor data should be recorded every 10th second,
- Video footage recording should be made at each fishing trip from the start of the first fishing event to landing in port of call,
- in order to ensure that all catch handling areas are covered with video footage,
- VMS data should be reported at least every hour in order to make sure no fishing trip is carried out without the REM system running. GPS data is mandatory

A data handling and exchange system that ensures that all data of relevance is stored electronically allowing easy access to basic or aggregated data whatever is the most appropriate.

The system could be based on a data ware house where all sensor data is stored. Upload of sensor data automatically when coming within cell phone range. Data should be stored to ensure easy access to both basic and aggregated data. As mentioned above the haul by haul reporting enables a distinction of each fishing event. This is not only necessary in a control context, e.g. a vessel is setting one haul in a closed area or have discard after one specific haul but also for research use, e.g. calculation of CPUE.

The storage of video footage requires major hard disk capacity. Therefore, it is almost impossible to store video footage for all vessels for several month or years. A solution could be that video footage should be stored for a period of e.g. 3 months and then deleted unless any non-compliance has been found during the reviewing process.

Sensor data can be stored for a prolonged period (years) due to a diminutive storage requirement. Access to basic data is a requirement for most of the data users (authorities and the fisheries scientists) and is recommended but special arrangement should be made for the video footage as this is very sensitive because of privacy and confidentiality reasons.

During the trials a number of challenges arose, some of a more technical nature and others of a more human nature. The technical challenges could often be solved, such as change of the control box, cameras or repair of the cabling. Training of the crews and the skippers was a continual task to be done. Even though the fishermen are used to report in an electronic logbook it was realized that guidance on how to register information in the logbook correctly should be done repeatedly.

Among the most common flaws is the lack of information haul by haul of registered discards. Other flaws seem to be the result of negligence, e.g. cleaning camera lenses or the correct display of discards in front of the camera reducing the accuracy of the monitored discards.

It has been the general experience that close contact to the fishermen is necessary in order to correct the working routines on board. There can be foreseen a significantly increased workload in relation to the data analysis if additional species are included in the CQM.

Implementation of a discard ban and the use of REM system would ease the video footage review process significantly as it easily can be controlled whether discard has taken place. However, it should be mentioned that it is probably possible to adapt to a discard ban on the larger vessels as these vessels have enough storage room for catches that are traditionally discarded. The consequence of a discard ban for smaller vessels can be shorter fishing trips.

During the Danish trial the issues about choke species has not created any problems. This is probably due to the Danish national management system where individual fishing concession rights have been implemented. According to the national management rules all species that can be landed legally must be landed. In case a vessel has fished its full quota of any given species excluding cod, the vessel has two options: either to lease additional quota or to discard the catch. In case a vessel has fully exploited its cod quota, it will need to lease additional cod quota or cease fishing.

From the Danish experience it is recommended to maintain a variety of sanctions that can both deter fishermen from committing new offences and remain proportional to the infringements. This entails the use of fines in less serious cases and the use of harsher measures such as the withdrawal of quotas and fishing permits in more serious cases of infringement of fishing rules.

5.5. Scope of result based management

Result based management offers a number of new perspectives to science, fisheries management and wealth generation.

Result based management may be based on a simple TAC outtake, but it may also be used to apply an age structured outtake of the given stock. Present management operates with the TAC supplemented by regulations (e.g. mesh size) to ensure that only fish above a given size is caught. The targeting of increasingly bigger fish may influence the genetic pool of the species and forbid the optimal long term output. In result based management it is possible to set either TAC's for the individual size groups already used in the market regulation or to incentivize a more diverse outtake of sizes by multiplying catch amounts with coefficients for the individual size group. Admittedly it is a crude instrument. However it stands to prove and the present selection in "over and under minimum size" may prove not to be optimal.

The perspective of public deregulation is interesting in relation to a more simple and coherent public management and consequently fewer rules to control. On control, the most interesting perspective of full documentation seems to be the consequential reduction in expensive seagoing control. Furthermore, the development of technology and smart risk based control should give a continuous reduction in control costs. Finally the transfer of costs to the industry for the on board documentation seems obvious.

With regard to wealth generation it seems obvious that the fisherman is better served by the choices of fishing methods he can make in time and space than by generally applicable rules. Furthermore CQM and full documentation combined with traceability (required by the control regulation) will ensure a both traceable and validated fishery. Promoting fish can be done in good faith with an increasing inclusion of information that consumers may reward and do away with the uncertainties.

Result based management achieves its objectives by setting and managing targets instead of regulating behaviour or choice of methods and technology. It is suitable for use in environmental management where targets can be defined in a way that is meaningful in relation to the desired objectives and relevant for the industry to optimize against in a commercial context. Targets should be measurable impacts such as maximum pollution effect from an activity or a maximum outtake from a natural resource.

Used in the right context result based management will have coherence between objectives and management and it will incentivize the industry to optimize value within the set targets. This will take place as a successive improvement of the result/impact relation in the production.

Result based management is characterized by

1. Clear and relevant targets
2. Reliable documentation from the industry that targets are met
3. Opportunities to establish a circle of knowledge building and better practices. And to accelerate the speed by subsidizing user driven innovation

Fisheries management is a clear candidate for result based management when it comes to stock utilization and more difficult to apply in relation to secondary effects of fishing; e.g. in relation to habitats.

The CFP is based on TAC/quota management (outside the Mediterranean), where one of the most important objectives is to ensure that TAC/quotas are respected thereby respecting the targeted fishing mortality. The present management is based on an account of the catches actually landed and a complex regulation aiming at reducing unaccounted catches, such as various forms of discard.

Catch Quota Management on the other hand is result based. It manages the primary target, the total catch, and it requires the fisherman to give a reliable account of his total catch by electronic surveillance (e.g. CCTV and sensor systems).

CQM meets or supports a number of objectives. The objective of adhering to TAC/quotas is aligned with the management in itself. The objective of balancing fleet capacity with fishing opportunities is supported as the incentive to exert a high fishing effort is neutralized by the fact that high grading will no longer be a cost to society (an externality) but a cost to fishermen, as it will cost on the quota. The objective to ensure "all fish landed" is supported by the very same incentive and the improved knowledge about catch patterns that full documentation offers. The wish to remove micro management is met by the nature of the management in itself. The objective to improve scientific advice is supported by the reliable data provided by CQM vessels and the opportunity to improve forecast models in quality and real time through development of reference fleets with full documentation.

For CQM to work one qualification is necessary: that documentation of catches is reliable. If CQM is not applied for the whole fleet another qualification should be added: That vessels not having full documentation have their quotas reduced with an amount equal to their calculated discards, given a precautionary approach to the uncertainties attached to such a calculation. This will ensure an improved collection of data from such vessels, and incentivize a transition into full documentation.

For the industry an important advantage is that management of time at sea and choice of methods and technology can be removed or simplified, and that they can meet the consumers demand for documented and traced fish products, thus removing the existing price barrier resulting from uncertainties of sustainability. Perhaps more important is that TAC/quotas can be increased as there is no need to take account of discards on public level. This will lead to an advantage for the vessels with low discards as opposed to the situation to-day.

Fishermen will meet a new challenge inherent in CQM. Balancing the catches with the quotas available will be a new requirement as a fishery can only be conducted if quotas are or can be made available. In a mixed fishery this may entail that a fisherman having quota for one species but not for the other must refrain from participating in that particular mixed fishery or obtain additional quota from a transferable quota system. The alternative, discarding the non-quota species, is not an option in CQM. If CQM is applied in a gradual phasing in of species it seems likely that lost catch opportunities in the fisheries in the North Atlantic can be kept at a low rate – certainly compared to actual losses as a result of discards.

CQM is also applicable in relation to protected and endangered species in cases where it is relevant to set maximum targets for by-catches of these species. Combined with full documentation a release requirement and data on survival for released specimens it is possible to manage such by catches to the benefit of an optimal outtake of the targeted commercial species.

6 Acknowledgement

The Danish Ministry for Food, Agriculture and Fisheries, Danish AgriFish Agency and the European Fisheries Fund has funded the project.

We would like thank vessel owners, skippers and crews onboard the participating vessels for their cooperation and for providing feedback throughout the whole project period.

Help and guidance have during the project been given by Archipelago Marine Research Ltd. and especially thanks to Howard McElderry and Morgan Dyas.

Finally, thanks to all colleagues that have been analyzing the sensor data reviewing the video footage.

7 References

Dalskov, J. & Kindt-Larsen, L., 2009. Fully documented fishery. DTU Aqua report. Available at: <http://www.aqua.dtu.dk/upload/dfu/kameraforsoeg/final%20rapport%20300809%20v3.pdf>

Dalskov, J., K. Birch Håkansson & H. J. Olesen, 2010. Danish Catch Quota Management project 2010. DTU Aqua report. Available at: http://www.aqua.dtu.dk/upload/aqua/publikationer/forskningsrapporter/235-2011_final-report-on-the-danish-catch-quota-management-project-2010.pdf

Pascoe, S., J. Innes, D. Holland, M. Fina, O. Thébaud, R. Townsend, J. Sanchirico, R. Arnason, C. Wilcox, and T. Hutton: Use of Incentive-Based Management Systems to Limit Bycatch and Discarding. *International Review of Environmental and Resource Economics*, 2010, 4: 123–161

Colophon

Danish Catch Quota Management trials – application and results

By Jørgen Dalskov, Hans Jakob Olesen, Erik Møller, Søren P. Jensen, Mik Jensen, Flemming Schultz og Mogens Schou

November 2012

DTU Aqua, National Institute of Aquatic Resources

DTU Aqua report no. 256-2012

ISBN 978-87-7481-160-2

ISSN 1395-8216

Cover Design: Peter Waldorff/Schultz Grafisk

Cover Photo: Peter Jensen

Reference: Dalskov, J., Olesen, H. J., Møller, E., Jensen, S. P., Jensen, M., Schultz, F. & Schou, M. (2012). Danish Catch Quota Management trials – application and results. DTU Aqua report no. 256-2012. Charlottenlund. National Institute of Aquatic Resources, Technical University of Denmark, 28 p.

DTU Aqua reports are published by the National Institute of Aquatic Resources and contain results from research projects etc. The views and conclusions are not necessarily those of the Institute.

The reports can be downloaded from www.aqua.dtu.dk.

DTU Aqua
National Institute of Aquatic Resources
Technical University of Denmark

Jægersborg Allé 1
DK-2920 Charlottenlund
Tel: + 45 35 88 33 00
Mail: aqua@aqua.dtu.dk

www.aqua.dtu.dk