

# Final Report of Fully Documented Fishery

DTU Aqua report no. 204-2009

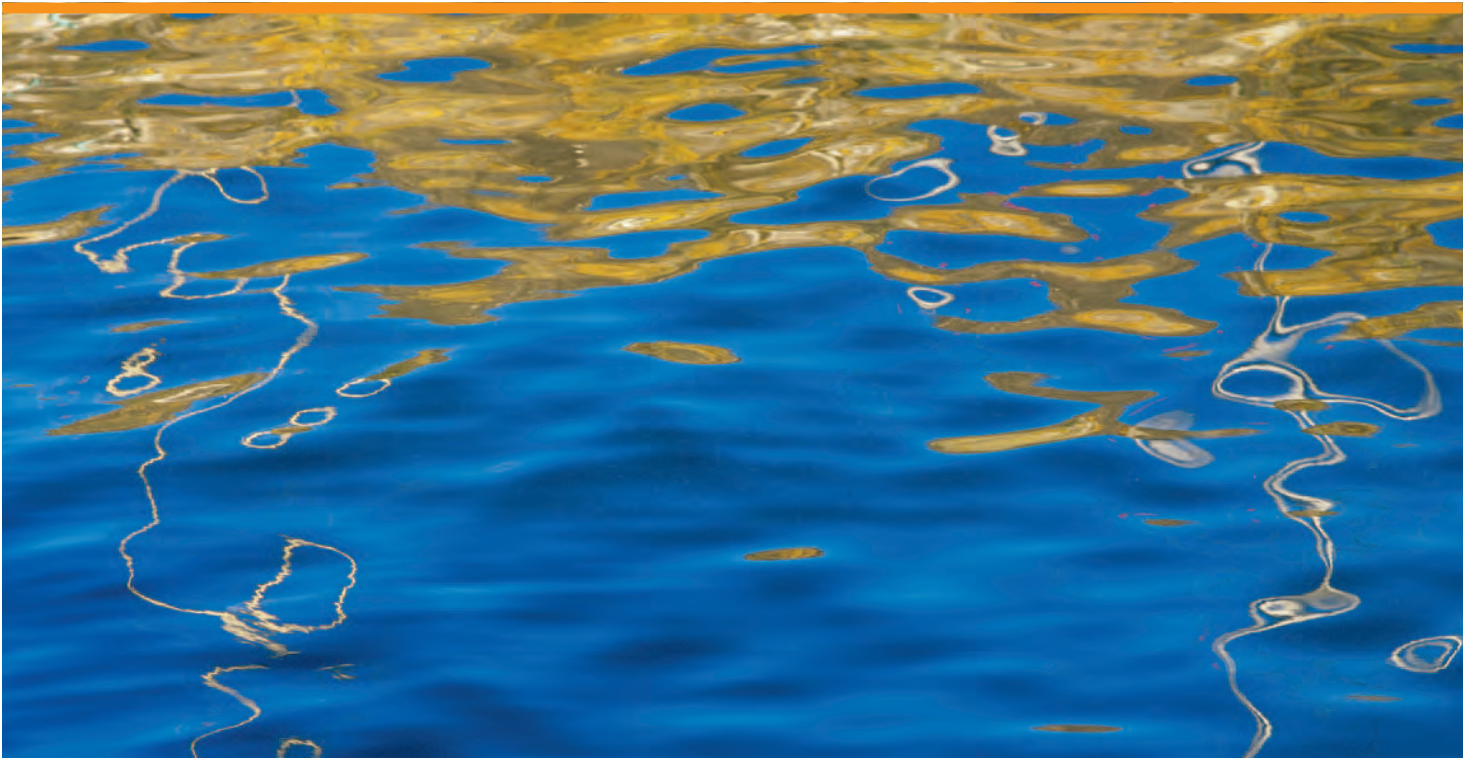

By Jørgen Dalskov and Lotte Kindt-Larsen

## Colophon

### **Final Report of Fully Documented Fishery**

By Jørgen Dalskov and Lotte Kindt-Larsen

September 2009.

DTU Aqua, National Institute of Aquatic Resources

DTU Aqua report no. 204-2009

ISBN: 978-87-7481-095-7

ISSN 1395-8216

Cover design: Peter Waldorff/Schultz Grafisk

Cover photo: Peter Jensen

Reference: Dalskov, J. & Kindt-Larsen, L. (2009) Final Report of Fully Documented Fishery. DTU Aqua report no. 204-2009. Charlottenlund. National Institute of Aquatic Resources, Technical University of Denmark, 49 p.

**DTU Aqua reports** are published by the National Institute of Aquatic Resources and contain results from research projects etc. The views and conclusions are not necessarily those of the Institute.

Newer reports can be downloaded from [www.aqua.dtu.dk](http://www.aqua.dtu.dk). Older reports that are not published on the website can be borrowed from the Institute's libraries in Charlottenlund and Lyngby. See addresses below.

DTU Aqua  
The Library  
Charlottenlund Slot  
DK-2920 Charlottenlund  
Tlf.: + 45 33 96 33 14  
[ca@aqua.dtu.dk](mailto:ca@aqua.dtu.dk)

DTU Aqua  
The Library  
DTU, Bygning 221  
DK-2800 Lyngby  
Tlf.: + 45 45 25 25 84  
[stc@aqua.dtu.dk](mailto:stc@aqua.dtu.dk)

# FINAL REPORT

## on

# Fully Documented Fishery

by  
 Jørgen Dalskov & Lotte Kindt-Larsen  
 National Institute for Aquatic Resources  
 Technical University of Denmark  
 September 2009

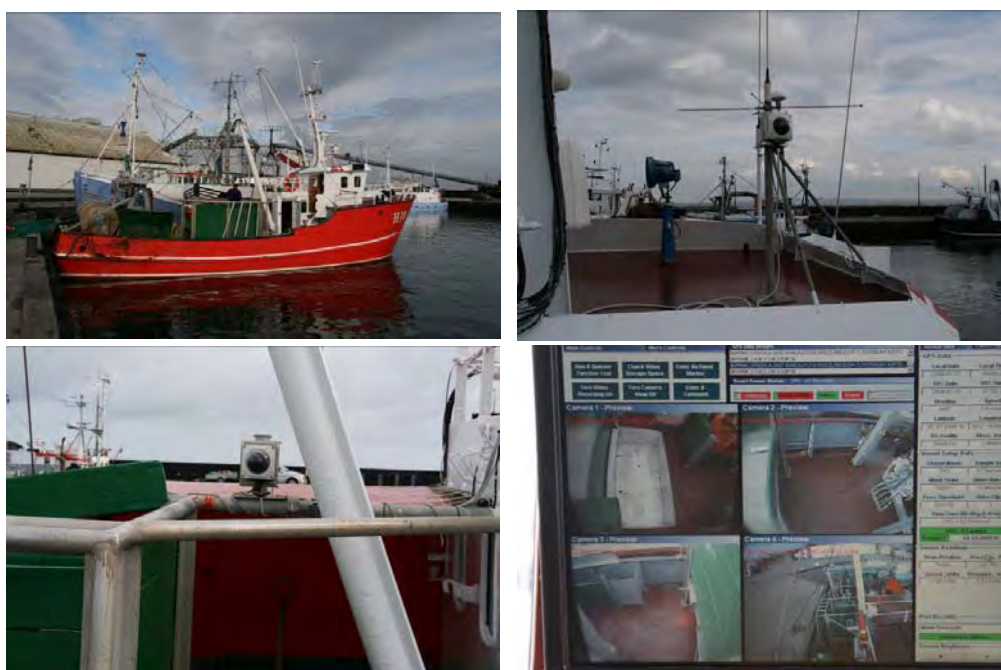

Denmark and The EU invest in sustainable fishing.  
 The Project is supported by the Ministry of Food, Agriculture and Fisheries and The EU

Ministry of Food, Agriculture  
 and Fisheries



The European  
 Fisheries  
 Fund



## EXECUTIVE SUMMARY

The Danish Government platform in November 2007 announced that Denmark would table a proposal for a change of the Common Fisheries policy towards a management system based on incentives and transparent and understandable rules.

Minister of Fisheries Eva Kjer Hansen in September 2008 presented a comprehensive proposal to the Council of Ministers. The limitation of fishing opportunity by TACs and quotas remains the primary tool in the minister's proposal. However, the TACs and quotas should relate to the total catch and not only to the landings as it is the case in the present management system. This means that the fishermen would be accountable for their total catches, including eventual discards and not only the part of the catch that is landed. The total catch accounting system (catch quota scheme) should be implemented gradually on a voluntary basis and fishermen should have an incentive by way of increased quota that compensates for the requirement that both retained and discarded catches are decremented against their held quota.

A requirement for entering into the new catch quota scheme is that the fishers operating under the scheme must have comprehensive, complete and reliable documentation of all their catches including discards. In order to demonstrate whether a "Full Documentation by Electronic Observation" can deliver the required level of assured documentation, a one year pilot project was conducted by The Danish Technical University (DTU).

The electronic monitoring (EM) system used in the pilot project consisted of up to four closed circuit television cameras, a GPS receiver, a hydraulic pressure sensor, a gear rotation sensor and a system control box. The EM Systems were installed on seven volunteer commercial fishing vessels where the cameras provided view of the aft deck, closer views of the fish handling areas and discard chute areas for catch identification.

The objectives were to evaluate the reliability and functionality of the (EM) system as a tool to monitor discarding of cod in Danish trawl, gillnet and seine fleets, and the secondary objective was to document catch handling and observe the discard pattern to verify whether the fisher's record of discarding of cod was correct. Furthermore fishers' views regarding the system and the incentive effect have been evaluated.

The EM system has been collecting sensor data and images throughout the period September 2008 to July 2009. According to the vessel logbooks the vessels were at sea for 16,955 hours, carried out 561 fishing trips, and conducted 1,558 fishing operations during the project period.

The analysis of the sensor data (GPS, hydraulic pressure and rotation of the winches) showed that determination of where and when a fishing operation takes place can be made with a high degree of accuracy. In addition, by viewing the video imagery it can be determined whether the vessel was actually fishing or for example, just cleaning their net.

An estimate of the total catch amount and the species composition can be made by reviewing the video records of the catch handling onboard. The focal point for this project has been the documentation of discards of cod. The results of the pilot project showed that the estimate of discards of cod by view-

ing the video records can be made with high accuracy, especially if the vessel had a sorting conveyor belt where the discarded fish passed the discard chute individually. If large amounts of discards occur the accuracy of the estimated discard amounts decreased unless specific onboard catch handling protocols were followed. The conclusion is that image quality of the video recordings is very high and can be used to provide reliable estimates of species and size composition of the catch and eventual discards.

The cost for documenting a vessels fishery using EM is significant lower than obtaining the same documentation using onboard observers. The analysis showed that on average less than one hour data analysis and image viewing was required for verifying one fishing event and the associated catch handling.

The experiences gained during the pilot project have shown that the fishers have been more active in avoiding catches of small cod. If large quantities of small cod were caught the fisher would change fishing grounds or even try to change mesh size. Furthermore, there has been a positive reaction from the fishers and they have shown an increased awareness of their fishing patterns. The idea of giving the individual fishers an incentive to reduce discards by introducing a catch quota system where all catches (retained and discarded part) are counted against the quota and the fisher is responsible for documenting his fishery can be seen as a way forward toward sustainable fishing where the catches are utilized optimal.

The electronic monitoring system has proven its reliability. The experiences obtained during this pilot project have shown that the EM system can be applied on almost all types of pelagic vessels and the vessels fishing for sandeel, sprat, blue whiting and Norway pout and larger demersal fishing vessels fishing for human consumption purposes, where it can give a 100% documentation of the fishing activities. Onboard some other vessels it may be necessary to modify vessel deck setups and interior catch handling flow in order to obtain appropriate image coverage for the full documentation processes.

<b>EXECUTIVE SUMMARY</b> .....	3
1 INTRODUCTION .....	6
2 METHODOLOGY.....	7
2.1 Selection of vessels to be used for the project.....	7
2.2 EM System Specifications.....	9
2.3 Data Capture Specifications .....	11
2.4 EM Pilot Project Operations.....	11
2.5 EM Data Interpretation.....	11
2.5.1 Sensor Data Analysis.....	12
2.5.2 Image Data Interpretation.....	12
2.5 Data Reporting .....	13
3 RESULTS .....	14
3.1 Collected data.....	16
3.2 Fishing event analysis .....	17
3.3 Catch data analysis.....	20
3.4 Analyzing time and image quality.....	21
3.5 Observer data analyses .....	22
3.6 Landing data analysis .....	23
3.7 Length distributions of cod discards.....	26
4 DISCUSSION .....	28
4.1 EM system - hardware.....	28
4.2 Image data .....	28
4.3 Sensor data .....	33
4.4 Fishers involvement .....	34
4.5 EM and surveillance perspectives .....	35
4.6 Cost issues.....	36
5 CONCLUSIONS AND RECOMMENDATIONS.....	37
6 REFERENCES .....	39
7 ACKNOWLEDGEMENT .....	39
8 APPENDIXES .....	40
Appendix 1 .....	40
Appendix 2.....	44



## 1 INTRODUCTION

In November 2007 the Danish government put forward a new government platform stating the following objective for the fisheries policy:

*“The government will put forward a proposal for a New Common Fisheries Policy. Since the CFP was introduced, the rules have become more and more complicated. A new policy must ensure a more simple management and it must reward sustainable fishing.*

The present TAC and quota system has not restricted fishing mortality to levels consistent with maximum sustainable yields and for many stocks in Community waters there is a substantial gap between the reported total landings and the actual total outtake of the stock.

TACs and quotas remains the primary tool in the Danish Government’s proposal for a New Common Fisheries Policy (CFP). However, the individual fisher should be accountable for their total catch, not only the quantities landed at port. This requires that discards as well as landings be decremented against their quotas.

The proposed new resource management scheme would make the individual fisher responsible for the impact their fishing activities have on the stocks rather than just being accountable for the fish landed. Fishers should be given the freedom to optimize catches in relation to impact and they will have to carry the responsibility of documenting their activities.

The proposed scheme requires that all catches and not only landings are monitored, reported and can be documented. In order to demonstrate whether a “Full documentation by electronic observation” can deliver reliable documentation of catches the National Institute of Aquatic Resources (DTU Aqua), Technical University of Denmark late in 2007 started preparing a one year pilot project.

In January-February 2008 DTU Aqua carried out a feasibility study to evaluate the Electronic Monitoring (EM) technology developed by Archipelago Marine Research Ltd. (Archipelago), Victoria, BC, Canada. The feasibility study concluded that the combination of proprietary software and extremely durable hardware allow EM systems to collect pertinent at-sea commercial fishery data. When powered, EM systems are capable of continuously logging data on vessel position, hydraulic pressure, and winch or drum rotations as well as capturing high quality digital imagery of catch.

Based on the results of the feasibility study DTU Aqua initiated a pilot project for the period May 2008 to September 2009.

The objectives of the project were:

- To test whether electronic monitoring can be used to provide reliable documentation of the fishing operation and the catches.
- To demonstrate that a fully documented fishery can ensure:
  - that total catches - landings and discard – are recorded,
  - that a vessel self sampling system provides data useful in the scientific assessment of the fisheries and the stocks,
  - an improved economy for participating vessels,



- a documentation that can be used in evaluating the sustainability of the fishery.
- To investigate how a fishery management system where vessels with full documentation get incentives in the form of increased fishing possibilities will change or modify the behaviour and fishing patterns of the vessels involved.
- To minimize discards of cod in the Danish fishery.

To assess the suitability of EM system for various fishing and vessel types, and obtain skipper and crew feedback on the acceptability and suitability of EM systems.

## 2 METHODOLOGY

Archipelago has successfully developed and deployed video based electronic monitoring (EM) on a variety of fisheries, gear, and vessel types (McElderry *et al.*, 2005, McElderry *et al.*, 2006, McElderry, 2008). Therefore, DTU Aqua decided to use the EM system developed by Archipelago in this pilot project.

The detailed project planning began in July 2008 where staff from DTU Aqua and Archipelago met to discuss operational issues for the project and to review specific information requirements. At the same time, a contract between DTU Aqua and Archipelago Marine Research Ltd. was signed. The contract included provision of hardware (EM systems), software for data analysis, and consultant assistance where Archipelago staff would train DTU in installing hardware on the vessels, the use of analytical software, and finally provide assistance on technical and scientific matters to ensure accomplishment of the project.





DTU Aqua purchased six EM systems and three backup systems in case of breakdown of one of the systems.



### 2.1 Selection of vessels to be used for the project

In May 2008 DTU Aqua solicited fishing vessels to participate in the pilot project. Among the total number of volunteering vessels 6 vessels were selected. Four trawlers: HM 555 “Kingfisher”, S 85 Frk. Nielsen, H 79 “Tiki” and ND 399 “Meonia”, one Danish seiner HM 423 “Fru Middelboe” and one gill-netter S 530 “Yokotani”. The ND 399 “Meonia” was sold in January 2009. In February 2009 a vessel to replace “Meonia” was selected and a contract with ND 176 “Søstrene” was agreed.

Specification of the participating vessels:

<p><b>HM 555 Kingfisher</b></p> 	<p>Homeport: Hanstholm  Vessel type: Trawler  Building year: 2007  Length over all: 31.3 m  BT: 467  Engine: 736 kW  Power: 220 AC</p>
---	--

<p><b>H 79 Tiki</b></p> 	<p>Homeport: Gilleleje  Vessel type: Trawler  Building year: 1976  Length over all: 17.1 m  BT: 49.7  Engine: 309 kW    Power: 220 AC</p>
<p><b>S 84 Frk. Nielsen</b></p> 	<p>Homeport: Skagen  Vessel type: Trawler  Building year: 1997  Length over all: 16.7 m  BT: 44.2  Engine: 220 kW    Power: 220 AC</p>
<p><b>HM 423 Fru Middelboe</b></p> 	<p>Homeport:  Hanstholm/Hirtshals  Vessel type: Danish Seiner  Building year: 1983  Length over all: 20.4 m  BT: 86.1  Engine: 219 kW    Power: 220 AC</p>
<p><b>ND 399 Meonia</b></p> 	<p>Homeport: Klintholm  Vessel type: Trawler  Building year: 1974  Length over all: 15.78 m  BT: 19.98  Engine: 216 kW    Power: 24 DC</p>

<p><b>S 530 Yokotani</b></p> 	<p>Homeport: Skagen  Vessel type: Netter  Building year: 1987  Length over all: 14.39 m  BT: 17.3  Engine: 80 kW    Power: 220 AC</p>
<p><b>ND 176 Søstrene</b></p> 	<p>Homeport: Klintholm  Vessel type: Trawler  Building year: 1983  Length over all: 16.57 m  BT: 19,9  Engine: 221 kW    Power: 220 AC</p>

## 2.2 EM System Specifications

The EM sensor systems comprised a GPS, hydraulic pressure transducer and a photoelectric drum rotation (winch) sensor (Figure 1). A more detailed description of the system is given in Appendix 1. Each vessel was also equipped with up to four waterproof armoured dome closed circuit television (CCTV) cameras providing an overhead view of the aft deck and closer views of the fish handling areas and discard chute areas for catch identification. Sensors and cameras were connected to a control box located in the wheelhouse. The control box consisted of a computer that monitored sensor status and activated image recording.

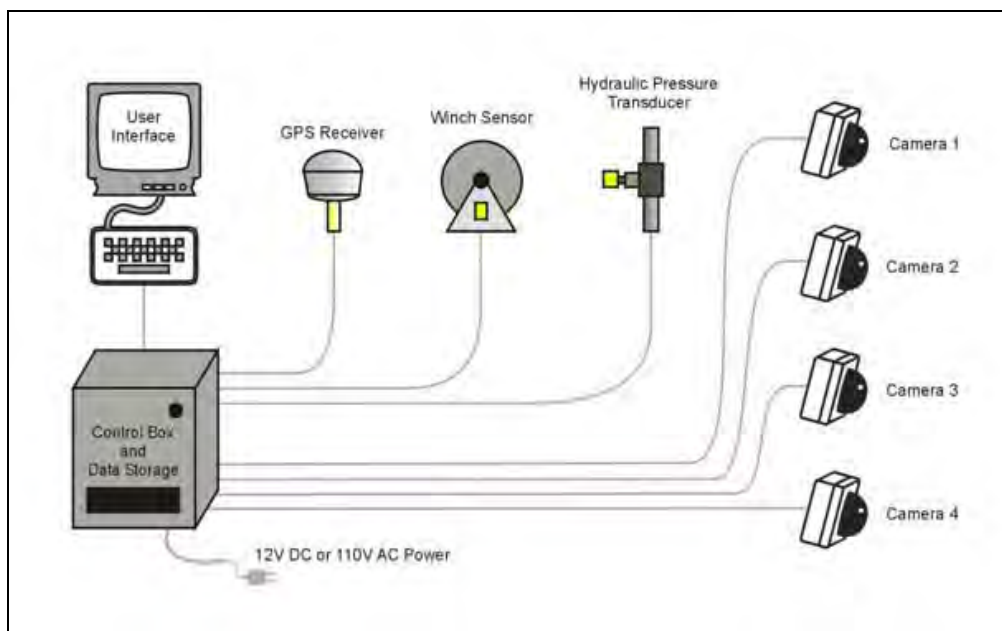

**Figure 1** Schematic diagram of the electronic monitoring system, which can record video data from up to four cameras per vessel.

The EM system's GPS receiver was mounted in the vessel rigging or on top of the wheel house and the electronic pressure transducer was installed in-line with the hydraulic system of each vessel. The rotation sensor was mounted on trawlers at one of the trawl wire winches, on Danish seiners at the rope drum and on gillnetters at the hauling machine.

Cameras were mounted in areas that required minimum fabrication while obtaining unobstructed views of catch handling and the discard chute areas. On each vessel, every effort was made to mount cameras and sensors in the best possible location. However, as a consequence of the temporary nature of pilot programs, camera placements were opportunistic and a more optimal placement for viewing the fishing operations may be possible in a permanent set up. During the project catch handling area on one of the vessels, the "Kingfisher", was renovated where all former conveying belts and gutting machines were removed and new gutting and filleting machines and new complete conveying belts were installed. In connection with this renovation new camera settings (camera location and view area) were tested.

EM control boxes were mounted inside the wheel house of each vessel, and sensor and camera cables were drawn to the wheel house either through ports already in place for hydraulic and electrical lines or in ports made by DTU Aqua staff.

The data logging program was designed to boot up automatically whenever powered, or immediately after power interruption. EM system power was provided by the vessel's 220V AC system.

The control box contained data storage capability for about 30 days of vessel fishing activity on 500 GB hard disc drives, and the computer was set to collect and store sensor data (GPS, hydraulic pressure and drum rotation).

## 2.3 Data Capture Specifications

EM sensor data was recorded continuously while the EM system was powered which, in principle, was constantly during the entire fishing trip (port to port). Image recording occurred from the beginning of the first fishing operation (when the pressure sensor or the rotation sensor was activated) until the vessel returned to port. All imagery included text overlay with vessel name, date, time, and position. Sensor data was recorded at a frequency of 10 seconds and data storage requirement was 0.5 MB per fishing day.

The EM system was capable of receiving video inputs from up to four CCTV cameras at selectable frame rates (frames per second), ranging from one to 30 (motion picture quality). During this project a frame rate from two to five frames per second was used which gives a data storage requirement of app. 60 – 300 MB per camera per hour, or about 400 - 1000 hours for four cameras and a 500 GB hard disc drive depending of frame rate setting.

## 2.4 EM Pilot Project Operations

During the first two weeks of September 2008 an Archipelago EM technician together with staff from DTU Aqua installed the EM system onboard the six vessels. Only two vessels had to be visited twice to correct the system setup and cabling. During the installation the skipper was consulted regarding positioning of equipment and cabling, and onboard electrical and hydraulic systems were assessed for optimal sensor placement, power requirements, and general EM system integration. At the completion of each installation, the EM technician powered the system and tested its components to ensure functionality. EM system performance has been monitored through regular service by DTU Aqua technicians.

To facilitate an evaluation of EM data collection staff from DTU Aqua participated as observers in a number of fishing trips. Partly to oversee the catch handling process, partly to check whether the recorded discard amount was correct, and to compare discards patterns on trip level with or without having an observer onboard. The observer also ensured that the crew had the required knowledge and expertise to run the EM system.

Staff from DTU Aqua was regularly in contact with the skippers in order to ensure their focus on the importance of the pilot project and to monitor the performance of the EM systems. When a hard disc drive was at app. 80 % capacity, the disc was exchanged with a new hard drive. When the data hard drive was received at DTU Aqua a backup of the data was saved on a server. The collected data was at a later stage comprehensively processed by DTU Aqua staff and by Archipelago staff.

## 2.5 EM Data Interpretation

The EM hard disc drives from the vessels were collected by staff from DTU Aqua for data storage and interpretation. Both sensor and image data were interpreted. All of the sensor data was interpreted within a server located at Archipelago's Victoria, Canada office. Data sets were interpreted by DTU staff and by Archipelago staff. Some data sets were interpreted by both for checking consistency in interpretation. All of the sensor data interpretation outputs have been delivered to DTU Aqua for final analysis.

Based on an analysis of representative EM data from the fishing vessels involved in the pilot, Archipelago staff provided a document outlining key issues involved with optimizing data collection for this project. The document described the sensor data interpretation outputs delivered, offered examples of useful ways of summarizing the data, and provided insights into the main sources of error in the interpretations that could lead to problems during analysis. Findings described in the Archipelago document have been included in the present report.

### 2.5.1 Sensor Data Analysis

The purpose of sensor data (GPS, hydraulic and winch rotation) interpretation was to determine the spatial and temporal parameters for start and end of each fishing trip and each fishing event. The key vessel activities including transit, gear setting, and gear retrieval were identified.

In this project, EM data was collected after several fishing trips were made. Thus, for each EM data set there were several individual landings. Interpretation was done for each data set as a unit, resulting in several 'departure' and 'return' entries for each data set. Fishing events were numbered chronologically for the entire data set.

EM sensor data interpretation was facilitated using software at a server situated at Archipelago. Using this software the sensor data was presented as time series and spatial plots. For illustration see Appendix 2 for the different vessels.

### 2.5.2 Image Data Interpretation

The objectives of image interpretation were to examine all fishing events, assess image quality and to assess the amount of fish caught for comparison with the catch amount recorded by the crew. The secondary objective was to document catch handling and observe the discard pattern to verify whether discards of cod were correctly monitored and recorded by the crew.

The video analyzer software used provided synchronized playback of all camera views although usually one camera view was used for catch determinations. The speed of image playback was varying depending on catch mixture and image quality. The trial demonstrated that the majority of imagery can be reviewed at a rate five to ten times faster than real time. In order to evaluate the consistency of EM viewer determinations, randomly selected imagery of fishing operations has been reviewed a second time by a different viewer and the results compared. Image quality was assessed as an average for the entire trip, using the following general scale:

- *High Quality* –camera lenses properly focused, viewing areas clearly visible, and gear retrieval and catch processing easy to assess.
- *Medium Quality* - some loss of resolution from pixilation, sunlight glare, or moisture; poor camera positioning, or minor obstruction of view but gear retrieval and catch processing still assessable.
- *Low Quality* –reduced light, increased pixilation, water spots on lenses, poor focus or major obstruction of view; fishing activity generally difficult to resolve.
- *No Data* –image quality low, or camera views totally obstructed, or no imagery available and therefore analysis not possible.



In general, the quality of the video imagery has been very high. Only rarely was the quality medium to low due to greasy lens hoods or water on the lens hood after cleaning up the deck. Weather, light conditions or other factors that can have an effect on the video quality has not been a problem during the trial.



**Figure 1** Example EM video snapshots from the Danish seiner vessel HM 423, Fru Middelboe showing a high quality view where the picture is clear for all the four cameras.

## 2.5 Data Reporting

The skippers on the six vessels were requested to report additional information in addition to the official logbook requirements. For each individual fishing operation the following information was recorded:

Date, time and position of shooting the gear, time and position of hauling the gear, total catch in weight, weight of retained part of the catch by species, total weight of discarded cod, length measurement of discarded cod, weight of discard of other species.

All sensor data was analysed by staff from DTU Aqua and by staff from Archipelago. The sensor data was used to determine date and time of fishing event start and fishing event end as well as the position of the fishing event as described in Section 2.5.1. The time used for carrying out the analysis is recorded in order to estimate man-power costs for this part of the analysis.

Video data was analysed by staff from DTU Aqua.

The discard video data were processed by dividing the discard into eight different categories.



- Unknown species (UBS)
- Cod (TOR)
- Norway Lobster (DVH)
- Rays and Skates (ROK)
- Flatfishes (FLX)
- Round fish (TFX)
- Invertebrates (INV)
- No Discards (NDI)

After each catch handling session the estimated weight of the 8 species or species group categories was noted in 9 different weight intervals 0-5kg, 5-10kg, 10-20kg, 20-50kg, 50-100kg, 100-250kg, 250-500kg, 500-1000kg and >1000kg. Before the data processing was started a small workshop was held to make sure that all DTU Aqua staff was estimating the discard correct and in uniform way.

### 3 RESULTS

Since the installation of the EM system the fishery was carried out according to the skippers and vessel owners fishing plans without any interference by DTU Aqua.

According to the official logbooks the vessels have in the project period been at sea for 17,192 hours, been running 599 fishing trips, and conducting 1,574 fishing events. Data for individual fishing vessels are presented in Table 1.

**Table 1. Number of hours at sea, number of fishing trips and number of fishing operations per trial vessel for the project period September 2008 – July 2009.**

Vessel	No. of hours at sea	No. of trips	No. of hauls
A	2,547	135	287
B	2,553	79	167
C	6,386	61	552
D	375	31	34
E	512	35	40
F	1,695	124	124
G	3,124	134	370
<b>Total</b>	<b>17,192</b>	<b>599</b>	<b>1,574</b>

Note: <sup>1</sup>Meonia stopped fishing by the end of December 2008 and Søstrene started mid-March 2009.

As described in Section 2.5, the skippers were required to complete an extended logbook in addition to the official logbook. Table 2 shows the number of trips and fishing operations carried out during the trial period according to the records made by skippers in the extended logbooks.

**Table 2. Number of trips and fishing operations carried out during the trial period according to extended logbook records made by the skippers.**

Vessel	No. of trips	No. of hauls
A	135	287
B	80	493
C	56	588
D	31	58
E	35	63
F	119	119
G	130	364
<b>Total</b>	<b>586</b>	<b>1,972</b>

Comparing Table 1 and Table 2 there is a difference in the number of trips and fishing operations made. This difference may be due to various reasons: i) according to the national logbook order fishing operations should only be filled in once a day; ii) change of skippers on the vessels; iii) especially for gill net fishery when to distinguish between one gill net set from another; and iv) just simply forgetfulness in completing the forms.

A major difference can be seen for vessel B. This vessel changed skippers during the trial period and the differences are likely due to a miscommunication. In January 2009 the vessels changed gear from Danish seining to gill netting for app. three months. Distinguishing one individual fishing operation from another may be difficult and has caused some differences in determination of fishing event using the official and extended logbook. In addition, 4-8 net sets can be made Danish seining using the same anchor points and in some cases one fishing operation for all the hauls in a day was made in the official logbook and several entries in the extended logbook.

For vessel C the difference is probably caused by recording one fishing operation for all the hauls in a day in the official logbook and several entries in the extended logbook, or just simply forgetfulness in completing the forms.

For vessel D and E it appears that the skippers forgot that recording in the official logbook should also be made on a haul by haul basis.

If a vessel leaves a port for fishing the fisher is required to fill in the official logbook. For gill netters there are occasions that they do not start fishing when the current above the sea bed is running too fast for fishing. In these cases the extended logbook was not been filled in. Accordingly there are differences for vessel F for the whole trial period and for vessel B in the first quarter of 2009.

Sensor data and images have been collected throughout the period beginning of September 2008 and until the end July 2009.

**Table 3. Number of trips and number of fishing operations recorded using sensor data used for this report.**

Vessel	No. of trips	No. of hauls
A	135	287
B	74	365
C	58	647
D	32	60
E	37	57
F	123	540
G	149	374
<b>Total</b>	<b>608</b>	<b>2,330</b>

### 3.1 Collected data

The EM systems were set up to be powered and collecting data for the entire duration of each fishing trip. A ‘time gap’ is a period of time where sensor data was expected to be collected but was not. When 100% of the data is successfully collected for a trip, a complete reconstruction of the trip can be created using the sensor and imagery data. As the level of time gaps increase, the system loses the ability to meet the program objectives as determining the total fishing effort, catch composition, and ensuring compliance issues such as catch retention and area restrictions are followed.

Gaps within the data sets need to be categorized as occurring within a fishing trip or not. Since the EM data were collected after several fishing trips, some gaps are expected in the data set, and ignored during analysis, when the vessels were at port between fishing trips. Time gaps can be further categorized according to the risk involved relevant to project objectives. For example, time gaps that occur when fish are on deck are deemed critical, as this is the period when discards are most likely to occur while small time gaps during vessel transit would be deemed of lower importance. Table 4 provides a summary of data set completeness for the participating vessels. The data record was nearly complete for most vessels and the overall data capture success was 97.9% for a total of nearly 17,000 hours of recorded data.

**Table 4. Sensor data collected in number of hours, the percentage of data completeness and the estimated number of hours fished.**

Vessel	Sensor data collected (hours)	Percent data complete	Fishing data collected (hours)
A	2,841.7	99.5	1,908.4
B	2,370.1	90.5	528.4
C	5,977.3	100.0	3,327.7
D	363.4	99.4	245.0
E	583.3	100.0	292.4
F	1,717.7	98.6	731.8
G	3,052.4	97.3	1,879.1
<b>Total</b>	<b>16,905.9</b>	<b>97.9</b>	<b>8,912.8</b>

**Definitions:**

**Sensor data (hours):** This is the time calculated between departure and return for each trip.

**Percent data complete:** =Sensor data hours - Time Gaps/Sensor Data hrs

**Fishing data collected (hours):** This is the time calculated between start and end for each set (as defined in No. of hauls).

### 3.2 Fishing event analysis

#### Sensor data registration of fishing events versus fishers' extended logbook registrations

The EM sensor data for start of fishing events was compared with logbook records in order to evaluate the event monitoring capability of the EM system. The difference in minutes between recorded start of fishing event and time reported in the logbooks was calculated. Table 5 below shows the relative distribution in time intervals of the differences. The results of this comparison show that in 48% of the recorded fishing events, the time difference was less than 15 minutes. In 26% of the fishing events the time difference was more than 60 minutes. The reasons for these relative large differences were mainly unsynchronised watches and changes from winter time to summer time. It can however also be due to the fishers' lack of experience in detailed recording of each fishing events since this is not a normal procedure for them. One of the fishers (vessel A) was accustomed to noting down each fishing events since he has previously worked for DTU Aqua in a number of scientific surveys. The data from this vessel shows very little inaccuracy with regard to event times. It is therefore believed that these time difference issues would be minimal when the fishers become more accustomed to the routine notation of event times.

**Table 5. Time difference given in % between the notations of fishing event made in the fishers' extended logbook and fishing notation notated using sensor data.**

Vessel	< 15 min	15-30 min	30-45 min	45-60 min	> 60 min	Total no.
A	95	1	0	2	1	572
B	25	25	6	16	28	757
C	34	13	8	14	31	1,102
D	70	3	1	11	15	75
E	32	1	2	28	37	126
F	37	10	6	16	32	237
G	46	3	1	15	35	708
<b>Mean</b>	<b>48 %</b>	<b>8 %</b>	<b>3 %</b>	<b>15 %</b>	<b>26 %</b>	<b>Total 3,573</b>

Table 6 shows the difference in fishing events positions recorded by fishers in the extended logbook compared with positions derived from the sensor data. In 77 % of the events the positions noted by the fishers and derived from the sensor data lied within a distance of 0.5 nm (nautical mile). For 16 % of the events the difference was larger than 1 nm. The reason for this difference was likely the uncertainty of definition and determination of when a fishing event actually started and ended. The skipper has to do boat handling when setting and hauling the gear and therefore may not have the time to record the position and time when the setting and hauling actually took place. The recording of position and time was therefore made later. This problem could be solved by using an electronic logbook where recording of events are done automatically from the EM equipment.

**Table 6. Distance difference given in % between the notations of fishing event made in the fishers' extended logbook and fishing notation notated using sensor data**

Vessel	< 0.5 nm	0.5 – 1 nm	> 1 nm	Total no.
A	95	2	3	571
B	51	3	46	756
C	51	24	25	1101
D	89	4	7	74
E	81	5	14	124
F	79	7	14	238
G	91	4	5	706
<b>Mean</b>	<b>77 %</b>	<b>7 %</b>	<b>16%</b>	<b>3570</b>

### Image registrations of fishing events versus sensor registrations

Analysis of imagery to determine when and where a fishing event takes place are usually not done as the sensor data is believed to deliver this information accurately. To verify if this was the case a large sub set of videos was analysed. In order to determine if sensor data and video are equally precise in registering fishing events, the differences in time (Table 7) and distance (Table 8) of the registrations in the two systems were found by comparing video data with sensor data. Regarding time differences the results showed that difference was less than 15 minutes in 95% of the cases (Table 7). When comparing the distances noted from each catch event the distance differed with less than 0.5 nm in 89% of the cases (Table 8).

Since the time and distance recordings from this experiment were almost identical and as processing of sensor data is much faster than image analysis it was decided just to use sensor data for registration of fishing events. However if sensor data for some reason was missing, video data could easily be used instead. It should be noted that as vessel D entered the project at a late stage no images have been analysed for time and position registration.

**Table 7. Time difference given in % fishing events notated using sensor data compared with video data.**

Vessel	< 15 min	15-30 min	30-50 min	Total no.
A	99	1	0	494
B	76	9	15	139
C	98	0	2	494
D	Not processed	Not processed	Not processed	Not processed
E	97	1	2	95
F	100	0	0	9
G	99	1	0	415
<b>Mean</b>	<b>95%</b>	<b>2%</b>	<b>3%</b>	<b>Total 1,626</b>

**Table 8. Distance difference given in % between fishing events notated using sensor data compared with video data.**

Vessel	0.5 nm	0.5-1 nm	> 1 nm	Total no.
A	99	0	1	494
B	75	8	17	139
C	67	31	2	494
D	Not processed	Not processed	Not processed	Not processed
E	97	2	1	95
F	100	0	0	9
G	95	4	1	415
<b>Mean</b>	<b>89%</b>	<b>7%</b>	<b>4%</b>	<b>Total 1,646</b>

#### **Image registrations of fishing events versus fishers' extended logbook recordings**

The registration of fishing events using EM images was compared with the fishers' logbook recording in the same manner as for sensor data. Table 9 show that 48% of the notations of fishing events are recorded with accuracy less than  $\pm 15$  minutes. A total of 26% of the events are registered with a time difference that is higher than 60 minutes. The main reasons for this difference are the same as was mentioned for the sensor data.

**Table 9. Time difference given in % between the notations of fishing event made in the fishers' extended logbook and fishing notation notated using video.**

Vessel	< 15 min	15-30 min	30-45	45-60 min	> 60 min	Total no.
A	93	1	0	2	4	392
B	22	24	7	16	31	215
C	21	13	12	8	47	600
D	Not processed	Not processed	Not processed	Not processed	Not processed	Not processed
E	37	0	2	26	35	100
F	88	13	0	0	0	8
G	27	1	0	34	37	411
<b>Mean</b>	<b>48%</b>	<b>9%</b>	<b>3%</b>	<b>14%</b>	<b>26%</b>	<b>Total 1,726</b>

Table 10 shows the difference in fishing event positions noted by fishers compared with positions from the video data. In 70% of the data the positions were noted with an accuracy of less than 0.5 nm and in 24% of the fishing events the distance between the registrations was larger than 1 nm.

The reason for this difference of more than 0.5 nm is probably because when reviewing the images for registration of fishing events only trawl doors out and trawl doors in is recorded. After the trawl doors are set into the sea the vessel can easily make a distance of more than 0.5 nm before the trawl doors are on the bottom (sea bed).

**Table 10. Distance difference given in % between the notations of fishing event made in the fishers' extended logbook and fishing notation notated using video**

Vessel	< 0.5 nm	0.5-1 nm	> 1 nm	Total no.
A	93	3	4	392
B	13	2	85	215
C	35	24	41	598
D	Not processed	Not processed	Not processed	Not processed
E	88	3	9	100
F	100	0	0	9
G	93	3	4	409
<b>Mean</b>	<b>70%</b>	<b>6%</b>	<b>24%</b>	<b>Total 1,723</b>

### 3.3 Catch data analysis

#### Discards of cod

One of the main purposes of this project was to examine whether it was possible to estimate the amount of cod discarded by viewing the image records of the catch handling onboard the trial vessels. When the analysis of the discard practises started it was planned to analyse all catch events. It was, however, realized during the project that it was not possible to follow that approach with the available resources. It was therefore decided for the gill netter to analyse at minimum 10% of the catch event and for all other vessels at least 20% of the catch events. The total number of catch events processed are presented in Table 11 below.

**Table 11: The total number of catch events which are processed from each vessel.**

Vessel	A	B	C	D	E	F	G	Total
Events	59	79	187	10	18	36	40	429

Table 12 shows the fishing events given as the percent of situations where the image viewer either had estimated less, more or the same amount of discard as the fishers. In 72% of cases the viewer and the fisher estimated the same amount of cod discard. There were however 19% of the occasions where the fishers estimated a larger discard amount than the image viewer. Looking at the results more closely, e.g. vessel C, there were 31% cases where the fisher's estimate was larger than the viewer.

Differences between the image viewer's estimate of discard quantity and the amount reported by the vessels were more common when the discard volume was large. The results suggest that it was difficult for the viewer to estimate with accuracy when a large number of fish were discarded and there was a clear tendency for the viewers to underestimate discards in these situations. If these large quantity discards events are removed from the analyses the percentages for vessel C the instances drop to 21% which then aligns with the other trial participants.

The results show that image recording of catch sorting can with a high degree accuracy be used to verify the actual amount of fish and shell fish that are discarded if the catch sorting working area onboard is arranged in a optimal way for image recording.



**Table 12. The percentage of fishing events where the image viewer either had estimated less, more or the same amount of discard cod as the fishers.**

Vessel	Fisher < Viewer	Fisher = Viewer	Fisher > Viewer	Total no.
A	4	85	11	53
B	8	69	23	39
C	12	57	31	77
D	0	90	10	10
E	0	82	18	17
F	5	62	33	21
G	35	60	5	20
<b>Mean</b>	<b>9%</b>	<b>72%</b>	<b>19%</b>	<b>Total 237</b>

#### Discard of other fish

Discard of cod was the main focus area in this project although when analysing the images, discards of other fish species were also noted. No analysis of this has been made. Viewer data shows that it has been possible to identify other species and to estimate their weight.

### 3.4 Analyzing time and image quality

After each catch processing event the image viewer recorded the time spend on the image analyses (Table 13). The view time differed from vessel to vessel and from fishery to fishery (eg. white fish fishery versus nephrops fishery). The working/sorting processes onboard were very diverse. If the vessel had a conveyor belt it was very easy for the viewer to analyse the discards. If the sorting table onboard was small and the discard chutes were small or narrow the time required to analyse the images increased significantly. In general, the more experienced the viewer was the less time required for image analysis.

**Table 13. Mean view time in minutes used for processing of catch event for each of the vessel.**

Vessel	Mean view time (min)	Total no. of catch events analysed
A	38	59
B	14	79
C	13	187
D	32	10
E	31	18
F	8	36
G	16	40
<b>Mean</b>	<b>22</b>	<b>429</b>

Note: Total no. of events analysed includes all event both those where cod discarded is recorded and event where no cod discard has been recorded.

As described in Section 2.5.2 the image quality was evaluated. Table 14 shows the proportion of video sequences analysed for image quality, categorised according to quality. Generally the image quality was very satisfactory. See Section 4.2 for a more details.

**Table 14. Show the number of 2 hours video analysed for image quality per quality category.**

Vessel	High (%)	Medium (%)	Low (%)	No data (%)	Total no. of 2 hour images
A	98	2	0	0	512
B	98	1	0	0	223
C	83	15	1	0	610
D	Image quality not analyzed				
E	99	1	0	0	104
F	100	0	0	0	9
G	100	0	0	0	430
<b>Mean</b>	<b>97%</b>	<b>3%</b>	<b>0%</b>	<b>0%</b>	<b>1,888</b>

### 3.5 Observer data analyses

As described in Section 2.4 observers from DTU Aqua participated in a number of trips onboard the vessels. Table 15 shows the number of observer trips and the number of hauls sampled for species distribution and for length measurements of the retained and discarded part of the catches.

**Table 15. Number of observer trips and the number of hauls sampled.**

Vessel	No. of trips	No. of hauls
A	10	12
B	2	3
C	4	16
D	3	6
E	1	1
F	4	11
G	6	6
<b>Total</b>	<b>30</b>	<b>55</b>

The total catch of cod estimated by the crew and the observer can be compared. The observer data represents 55 hauls whereas the total number of hauls made by the fishers is 1,972 hauls. In general there is a high agreement between the discard rates estimate using observers data and using fisher's data. Table 16 shows the proportion of cod discarded and retained using the observer's estimate.

For vessel E only one haul have been worked up by an observer and some uncertainty may be expected. Table 17 show the estimated weight of cod discarded and retained per hauls made the observer and the fisher.

**Table 16. The proportion of cod discarded and retained using the observer's estimate.**

Vessel	Observer	
	Discarded	Retained
A	8.3	91.7
B	2.0	98.0
C	0.8	99.2
D	9.1	90.9
E	0.1	99.9
F	0.2	99.8
G	3.3	96.7

With full catch documentation required of participating vessels, the proportion of cod retained and discarded can be estimated from fishers catch estimates. Table 17 shows the percentage cod that have been discarded and been retained onboard and landed.

**Table 17. The proportion of cod that have been discarded and retained onboard and landed using fisher's catch estimates.**

Vessel	Discarded	Retained
A	3.0%	97.0%
B	2.0%	98.0%
C	1.9%	98.1%
D	9.8%	90.2%
E	12.6%	87.4%
F	1.2%	98.8%
G	3.3%	96.7%

These discard rates can be compared with discard rates estimated by the standard observer programme for the period 2006-2008. The estimated of cod discarded for the Danish fishers using towed gear (trawl and Danish Seine) fishing in the North Sea and the Skagerrak has been estimated to app. 48% and for the Kattegat to app. 53 %. For the western Baltic the estimate is app. 9% and for the eastern Baltic app. 8% (Danish Data Collection Framework Programme 2008).

### 3.6 Landing data analysis

One of the conditions for vessel participation in the project was to retain all fish above the minimum landing size. For most species the price per kg increases with fish size and it is possible for a vessel to optimise the value of a quota by only retaining large fish and discarding small ones. This type of discard is commonly called high grading and often occurs for species and areas where catch opportunities and quotas do not match.

Four of the trial vessels have been fishing in the North Sea and the Skagerrak and a comparison between the four vessels and the rest of the fleet fishing in the same areas was made. Figure 2 shows the proportion of cod per size grade (size grade 1 are the large fish and 5 are small) per month for 2008 of all Danish vessels (trial vessels excluded) that have landed cod caught in the North Sea and the Skagerrak. Figure 3 shows the same results for the trial vessels that have landed cod caught in the North Sea and the Skagerrak.

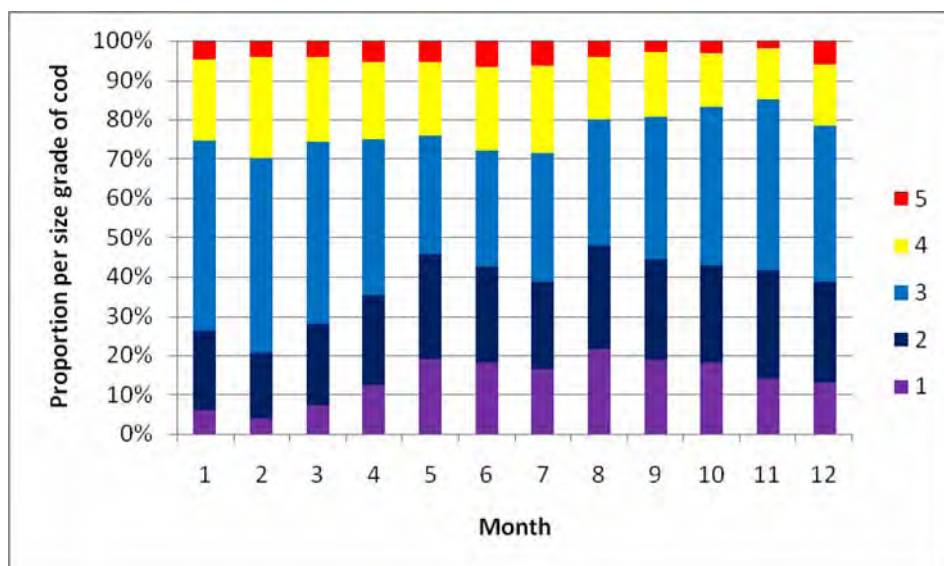

**Figure 2** Proportion of cod per size grade per month for 2008 for all Danish vessels (trial vessel excluded) that have landed cod caught in the North Sea and the Skagerrak.

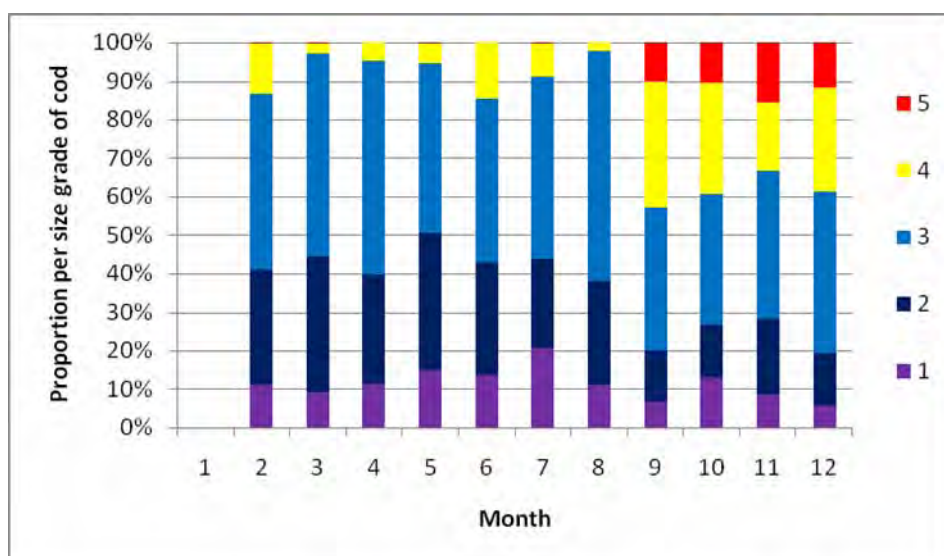
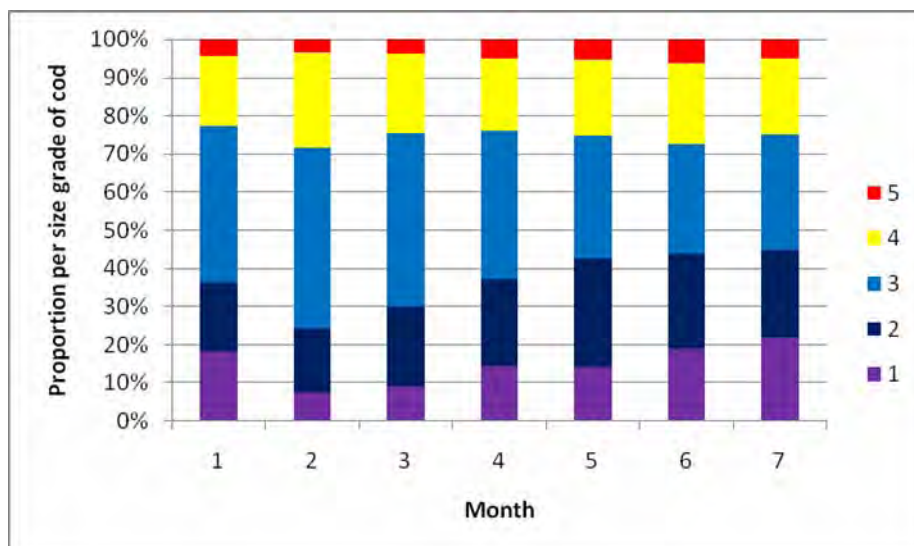

**Figure 3.** Proportion of cod per size grade per month for 2008 for the trial that have landed cod caught in the North Sea and the Skagerrak. The data for January is non typical and therefore not included.

The project started early September 2008. A significant difference between the four trial vessels, that were fishing in the North Sea and the Skagerrak, compared with other vessels fishing in the same areas can be seen for September - December for 2008. The first eight months of 2008 the size grade landing pattern is almost the same for the two groups. The result indicates that for 2008 a significant highgrading of cod occurred in order to optimize the revenue of the cod landings.

The same analysis can be made for the fishery in the same areas for the first 7 months of 2009. Figure 4 shows proportion of cod per size grade per month (January-July) for 2009 of all vessels (trial vessel ex-

cluded) that have landed cod caught in the North Sea and the Skagerrak. Figure 5 shows the proportion of cod per size grade per month (January-July) for 2009 for the trial vessels that have landed cod caught in the North Sea and the Skagerrak.



**Figure 4** Proportion of cod per size grade per month (January-July) for 2009 for all Danish vessels (trial vessel excluded) that have landed cod caught in the North Sea and the Skagerrak.

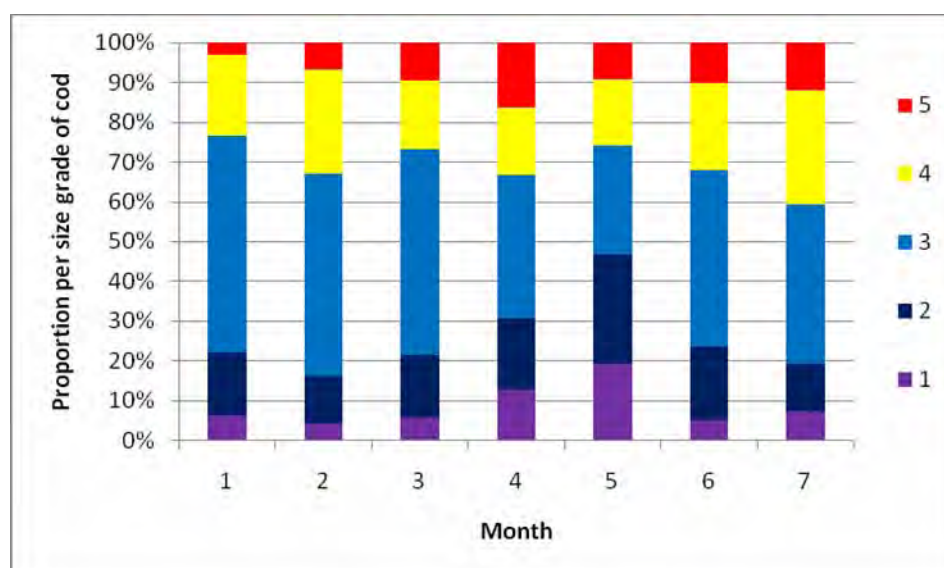

**Figure 5.** Proportion of cod per size grade per month (January-July) for 2009 for the trial that have landed cod caught in the North Sea and the Skagerrak.

The difference between the two vessel groups for the first seven month of 2009 is not as pronounced as for 2008. This difference may be caused by the significant increase (30%) of the TAC for cod in the North Sea and the Skagerrak from 2008 to 2009. The vessel quotas for 2009 may therefore be more in line with the actual fishing opportunity and this could have reduced the incentive to high grade.

Even though it is recognised that the results shown for the trial vessels are based on data for four vessel's fishery only the difference in size grade distribution between the two vessel groups is considerable and gives a picture of two different landing practises. Based on these analyses there was a clear indication of changes to fishing practices and catch handling and that discard of cod above the minimum landing size decreased or was almost nonexistent for the vessels that participated in the trial. Discard of cod below the minimum landing size also decreased (see Section 3.7).

### 3.7 Length distributions of cod discards

One of the requirements for the skippers and crew participating in the pilot was per haul to carry out length measurements of all or at least 50 specimens of the cod that they discarded.

A comparison of the length composition of cod that were discarded by the trial vessels fishing in the North Sea and the Skagerrak and the rest of the fleet fishing in the same area was made. The data collected by the trial vessels covers the whole trial period (September 2008 – July 2009) whereas the data from the rest of the fleet was collected by observers in the period 2006-2008. For the observer data a mean length distribution for three years has been calculated. It should be mentioned that the minimum landing size for cod caught in the North Sea is 35 cm and for the Skagerrak 30 cm. See Figure 6 below

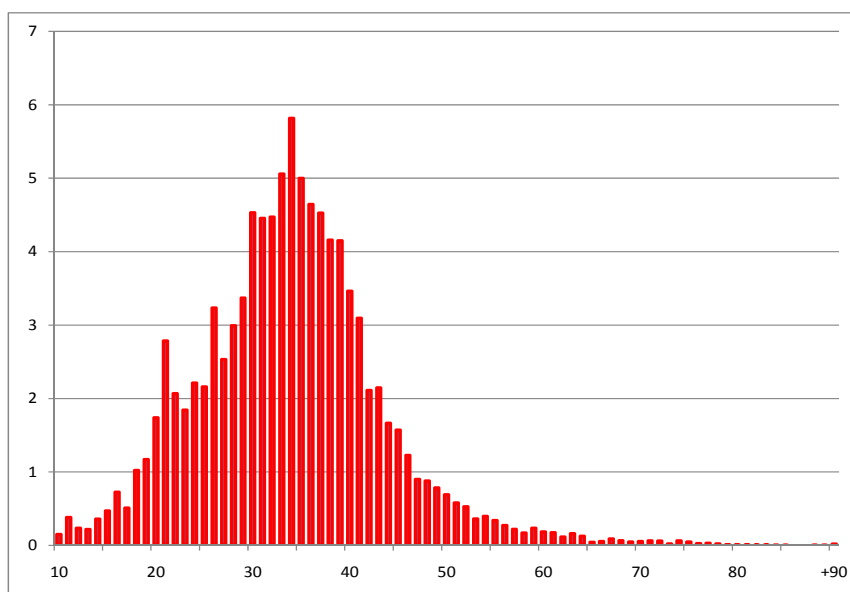

**Figure 6.** Length frequency distribution of cod that are caught and discarded by all vessels fishing in the fishing in the North Sea and the Skagerrak in the period 2006-2008.

It can be seen that cod above the minimum landing size were discarded. This pattern can be compared with the trial vessels that have been fishing in the same area (North and the Skagerrak). See Figure 7 below.

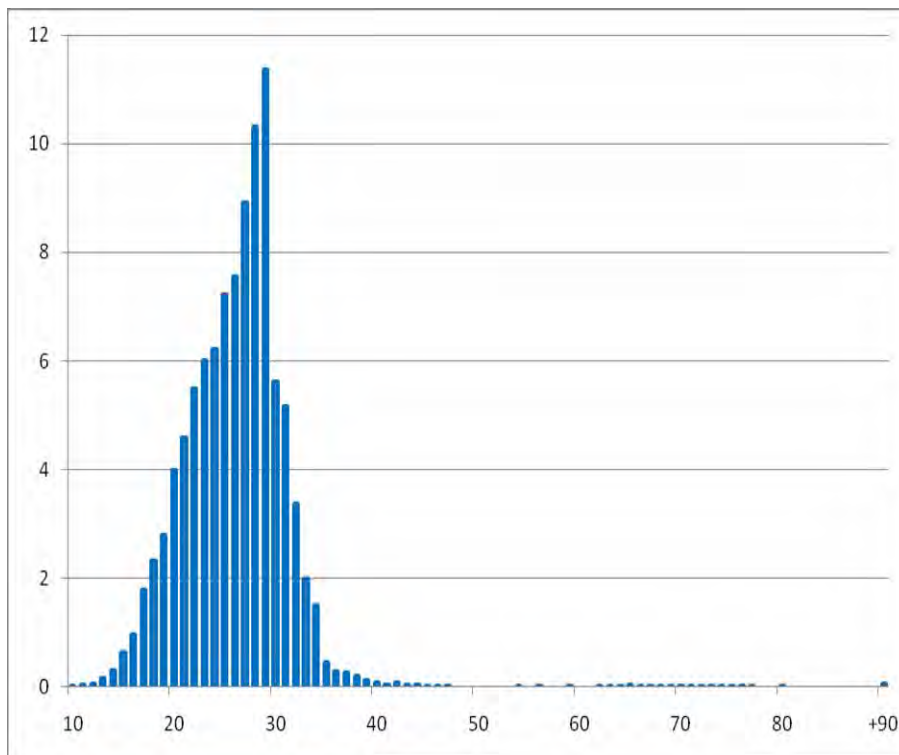

**Figure 7.** Length frequency distribution of cod that are caught and discarded by the trial vessel fishing in the North Sea and the Skagerrak in the period September 2008 to July 2009.

Even though the data presented in Figure 6 and 7 do not cover the exact same period, the picture shown supports the results of the analysis made on the size grade distribution of the landings described in Section 3.6. Note that the discard of fish below the EU minimum landing size is currently a mandatory requirement.



## 4 DISCUSSION

### 4.1 EM system - hardware

The EM systems were deployed on seven different vessels and under seven different environments in terms of dust, heat, cold and humidity. Furthermore, power supplies were different from vessel to vessel and not always stable with power failures happening a number of times. Despite these conditions the EM system developed by Archipelago was robust, reliable and worked well. During the data collection period 11 months (September 2008 – July 2009) only one system control box broke down because of an interruption of a file (software failure) and one camera failed due to accidental flooding when a crewmember washed it using a high pressure water sprayer. During the installation of one of the systems a cable broke and in the instance of one vessel electronic interference created some problems.

### 4.2 Image data

The main concept surrounding the image data interpretation was to ensure recording of videos to obtain clear images which could be used to verify fishing operations and catch handling procedures. In order to determine if camera settings used for this project could be applied in future electronic monitoring studies in Danish fisheries, a sample data set from this project was analyzed by trained staff at Archipelago. This section provides examples of useful ways for analyzing the video image data, and offers insight into necessary changes to camera configurations and crew behavior in order to help improve image data analysis and interpretation to apply to the remaining data set.

Sample image data from the six participating vessels was reviewed by staff from Archipelago to assess the feasibility to monitor for the project objectives using EM systems. Image data was reviewed using Video Analyzer at playback speeds ranging from 1.5 times real time to 4 times real time. The Archipelago EM viewer made detailed notes regarding: the camera configurations, image quality and the ability to assess for the project objectives. The EM viewer reviewed the image data from each of the trips provided, but did not record any catch specific data during analysis. Sample images of the different camera views and varying image data quality were taken from the participating vessels and are displayed in the following sections.

As part of image data analysis, every tow was rated for image quality and usability as described in Section 2.4.2. Image data quality is assessed as an average across all camera angles, while usability is determined based on specific monitoring objectives.

#### Effect of image quality

Image quality can be affected by a number of different factors including moisture in the lens, sun shield blocking view, water drops, low light conditions and bad sun glare. Figure 8 shows some examples of low quality image data from the participating vessels. Images A and B show views of the catch sorting area with reduced image quality due to low light conditions at night and water on the lens. Image C shows low light conditions during a night trip, while image D is an example of bad sun glare. Low image quality can significantly increase viewing time when identification of catch was very difficult and discarding events were hard to detect. Image data quality may be reduced to a level in which it is no longer usable. For example image B in Figure 8 is unusable for identifying catch in the sorting area.

Cleaning the lens on a regular basis can help reduce water drops and ensuring the sun shield is not blocking the field of view during regular services can help maintain higher image data quality. In addition proper deck lighting during night hauls can help alleviate the problem of low light.

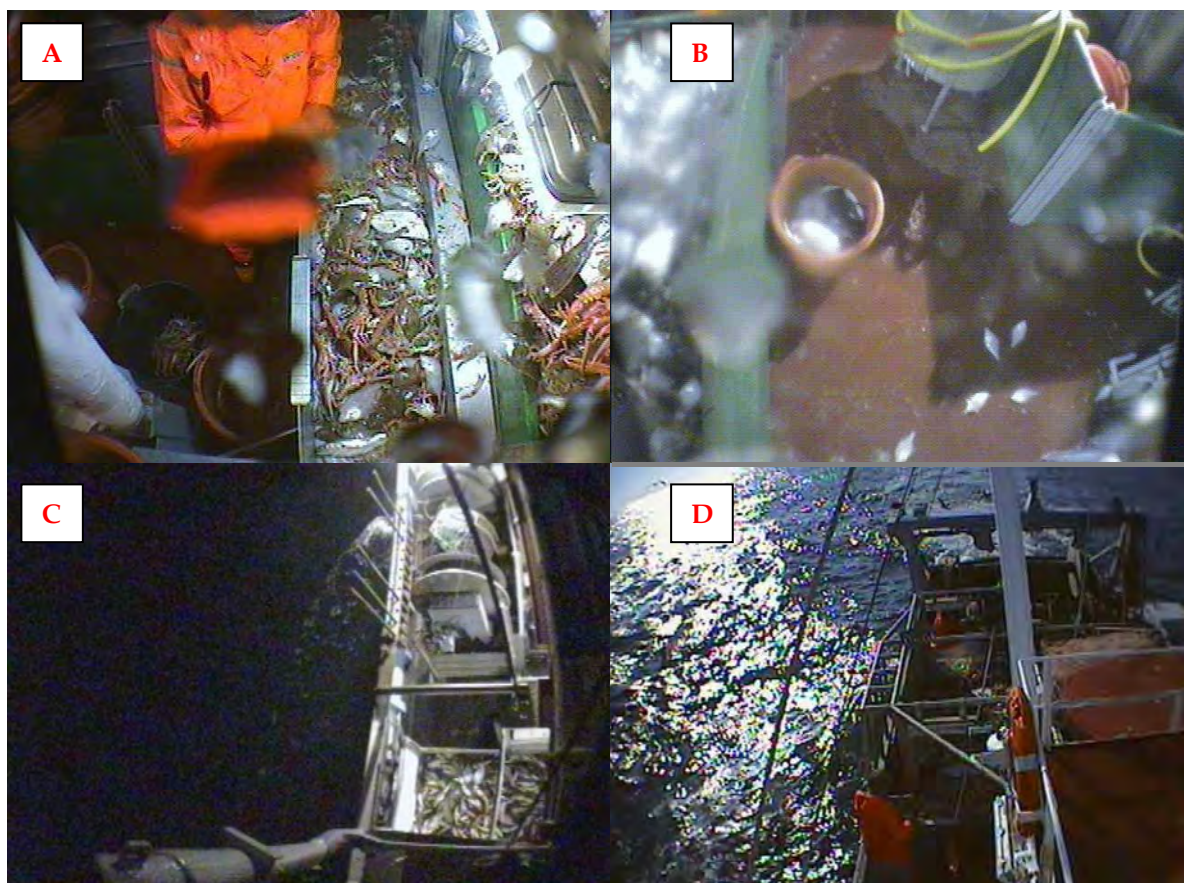

**Figure 8.** Images from the participating vessels showing examples of low quality image data. Images A and B-Low light conditions with water on lens, C-Low light conditions of a night haul, D-Bad sun glare against the water

### Catch composition

Images A and B shown in Figure 9 presents camera views used for catch identification from two of the participating vessels. Species groups such as skates, round fish and invertebrates could easily be distinguished using these camera angles; however identification to the species level was more difficult, therefore general species groupings may need to be used (i.e. Flatfish general). Image C is an example of a camera view in which identification of catch was not possible. The crewmember sorting the catch was obstructing the view of the catch and was located very far away from the camera. In order to improve this view, the camera should have been placed directly above the catch sorting area and looking down on the catch to provide a better view for identification. Image D is another example of a camera set-up that was very difficult to use for identifying catch. The field of view was only capturing part of the catch sorting area and was primarily filled with unnecessary deck space. To help improve this view the camera needs to be shifted upwards and towards the sorting area. With appropriate camera

angles (see top images of Figure 2) it was feasible to identify catch to either the species level or general species groupings within this fishery.



**Figure 9.** Sample images of good (A and B) and poor (C and D) camera views for identifying catch from several of the participating vessels.

### Discarding of fish and shellfish

In order to properly assess for discarding of catch, the EM viewer needs to be aware of all discard points on the vessel. Frequently crew will discard catch from several different locations and a single camera view does not capture all the discards occurring off the vessel. Several of the vessel's camera set-ups provided appropriate views of the discard points off the vessel and can be seen in Images A and B from Figure 10. For both vessels the camera views shown in Figure 10 are the only points of discard making the views ideal for assessing the discarded catch.

However, for some of the vessels the camera views did not properly capture the discarding events making identification of discarded species very difficult (see Figure 10). Image A from Figure 10 shows the sorting area from one of the participating vessels and a crewmember can be seen sorting catch into the discard shoot located on the far-hand side. However the nature in which the crew discarded the catch away from the camera view made identification difficult. This problem could be solved by moving the camera closer towards the location of the discard chute, more specifically moving it directly above and looking down on the sorting area and discard chute. When placing cameras



above a sorting area it is critical that the view remains close enough to allow for identification of catch. The further away the camera is moved the resolution will decrease making identification increasingly more difficult.

Image B of Figure 10 shows a good view of the net coming in with the catch, however the crewmember will throw discards over the rail of the vessel. The camera view was located such that the crewmember obstructs the field of view of the catch being discarded. The camera needs to be moved closer to the rail and angled to look down on the crewmember so the view is not obstructed. Images C and D in Figure 10 are deck views of the discard points for two of the participating vessels. While these views are good for seeing any large discard events it is not possible to identify any catch being discarded and therefore closer angles would be more appropriate for identification purposes.

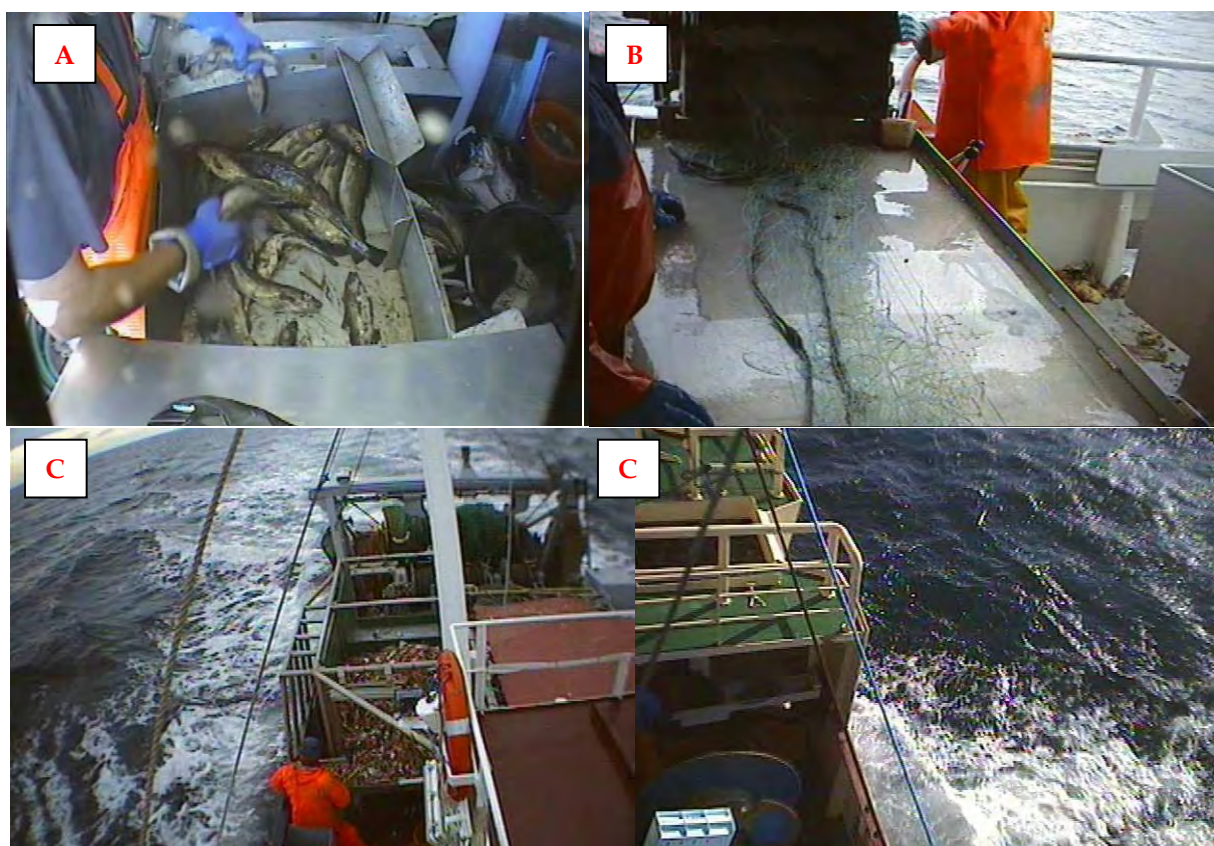

**Figure 10.** Sample images of poor camera views for assessing discarded catch, Images A and B are close up views with camera angles that make estimating discards difficult. Images C and D are over-view angles of discard points, however identification of catch is not possible from these views.

### Multiple sorting points

Frequently vessels will have multiple crewmembers sorting catch at a single time, and Figure 11 shows example images of this for two of the participating vessels. The top images show two separate sorting points for one vessel and in order for an EM imagery viewer to assess for discarding of catch these views would need to be reviewed separately. The same applies for the bottom two images showing multiple sorting points for one of the vessels. When the EM viewer is required to review individual cameras separately, this could potentially double the total viewing time for a each trip.

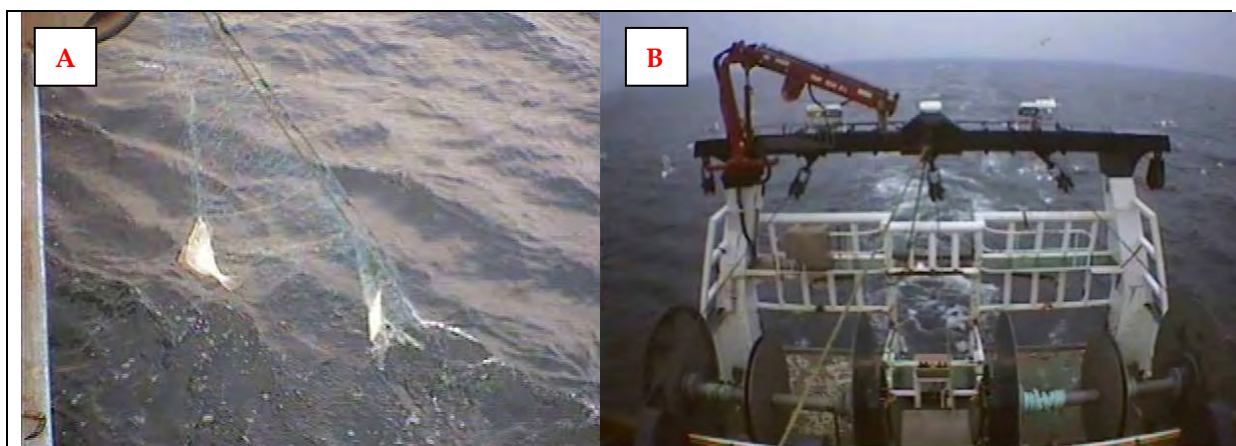

**Figure 11.** Example imagery from two of the participating vessels of multiple catch sorting locations. Images A and B show two sorting locations for one of the participating vessels. Images C and D are two separate sorting locations on one of the other participating vessels.

### Net coming on deck

Camera views were also set up to monitor the nets coming on deck and Figure 12 provides examples of this view from two of the participating vessels. Image A is a good view of the net coming in and drop-offs or discard events can be identified. Catch can be identified to a general species grouping using this camera angle, however identification to the species level would be very difficult. Image B shows an overview angle off the stern of the vessel, however the field of view is obstructed from being able to see the net coming on board. A camera placed at the very stern of the vessel would provide a better view of the net to allow for assessment of any large discard events.





**Figure 12.** Example images from two of the participating vessels for monitoring the net . Image A-is a good quality view of net coming on deck to assess for discards. Image B-Is a poor view for seeing the net coming on the stern of the deck.

#### **Summary on image data interpretation**

As described above and based on experience gained during this project it is of the outmost importance as to how the camera placement is made. When this trial started and the cameras were installed it was decided that no major changes of the vessels should be made in order to minimize costs. The trial has shown that for optimal results from electronic monitoring systems changes including the installation of extra lightning or extra places to mount cameras will often be required. Therefore, certain minimum requirements for vessel deck interior layout have to be set in order to optimize the quality of the video recordings and to ensure that nothing can be discarded outside the view of the cameras.

#### **4.3 Sensor data**

The purpose of sensor data interpretation was to determine the spatial and temporal parameters for the start and end of each fishing trip and event. The recording frequency of one record per 10-second interval, therefore sensor data provide very fine scale resolution of vessel activity during the fishing trip. The complete sensor data record for a month fishing trip can easily exceed 450,000 records. Specialized software tools are required to manage and interpret the data efficiently.

It is useful to think about what is the most adequate way to get an understanding on how each vessel carries out their fishing in order to understand if all data is collection in an optimal way. Therefore, it should be a consideration at each hard drive change or service event to determine if the data collection can be improved (i.e. were camera angles changed or sensor thresholds might be adjusted at each vessel visit) as this would have a significant impact on the data analysis results.

In this project, EM data was collected after several fishing trips were made. Thus, for each EM data set there were several individual landings. Interpretation was done for each data set as a unit, resulting in several 'departure' and 'return' entries for each data set. Fishing events were numbered chronologically for the entire data set.

When entering multiple departures and returns, it is important to enter both for each trip. When the totals for departures and returns do not match for a given work order number, this causes problems with trip definition, trip counts, trip durations and time gaps. Furthermore, if the departure or return point is unavailable due to a time gap (i.e. vessel did not turn on power until reaching the fishing grounds), it is important that the first or last point available should be entered. Not all start/end events were entered during this study and this has caused some confusion when defining the start and end of each trip.

It should be emphasized that it is very important that the control box be powered before leaving port and not turned off until returning to port. In addition, use of an E-logbook (linked to the EM system or a GPS) where date, time and position automatically is recorded just by pressing a key at the keyboard would alleviate a major problem in regard to validation of fishing event date, time, and location.

#### **4.4 Fishers involvement**

From the beginning of the project close contact and dialog has been achieved with all participating skippers and vessel owners. Meetings where preliminary results and experiences have been presented, discussed and commented on have been held and very valuable information was exchanged, achieving a level of close cooperation and understanding from both sides.

The main reason for the fishers to participate with the project was generally to show that the fishery does not have as large amount of discard as is often assumed by fisheries managers and the public. Hence the assignment of increased catch opportunities of cod was an important incentive in ensuring their participation. Before the fishers committed to the project their main concerns were related to the ethical (privacy) issues about being monitored, and the crews' reaction to this. However a short time into the project the crew accepted the video monitoring and did not find it problematic or disruptive for their normal working procedures.

Towards the end of the project the fishers were asked to fill out questionnaires to give their views on several issues. They were asked if they had become more aware of the catch composition and the discard volume and if they did something actively to reduce or avoid discards compared to previous practices.

Most of the fishers had become much more aware of the amount of small cod compared to earlier practice whereas several thought that they were just as aware as before. They had however been very attentive to ensure they had available quotas for landing cod as well for other species. Regarding avoidance of small cod some of the fishers had changed their behaviour in terms of changing fishing ground if they were in an area with many small cod, and in some cases, switched gear or mesh size to avoid them.

One of the most positive outcomes for the participating fishers has been the possibility of now being able to engage fishers in documenting their fishing activities and using EM to verify these data. Furthermore, to document what is taking place at sea and demonstrate that not all fishers and fisheries have high discard rates. More disappointing were the negative attitudes from colleagues and the fishers' organisation during the onset of the project. It should though be noted that those negative attitudes have changed somewhat to a neutral or even positive understanding that a fully documented fishery could be a benefit for the fishery and individual fishers.



The fishers who have participated in the project see a fully documented fishery as the future and would welcome the opportunity if such a system is introduced as a voluntary scheme for all types of fisheries. They consider a certain degree of incentive in terms of increased fishing opportunities to be crucial. If that incentive was less than approx. 20% of additional quota the fishers doubt that the scheme would be viable. If total catches of more than one species should be fully documented and counted against the vessel quota, some limits for the number of species should be considered as the extra sorting and recording tasks will be a burden on the fisher. Practical issues in regard to deck space and having enough baskets for sorting the catch into species may also be problematic as well as posing safety concern with many baskets "flying around" in bad weather. However if electronic reporting tools were introduced this could potentially reduce some of the extra work related to the fully documented fishery tasks.

The fishers were also asked whether some specific rules in the present fisheries management regulation were especially burdensome and to their opinion could be eliminated if fully documented fishery was implemented as an option. There was a general agreement that hauls for management area changes, departure, and active – passive reporting could be avoided or much reduced as the EM data could be used to check this information if needed.

Another important issue raised was the potential for year to year quota flexibility. If a bonus for participating in fully documented fishery were given this bonus may be estimated based on historical data. If a big year class of a species was entering the fishery there may be a high risk of catching a significant amount of undersized fish – which should be counted against the quota – that would almost certainly result in reduced revenue for the fishers and poor utilization of the stock. Therefore, a more adaptable year to year flexibility might be needed in order to give the fisherman an incentive to postpone catching the fish until they have achieved an acceptable marketable size. Such flexibility (a fishing moratorium) could form an important mechanism in the optimal utilization of the resource and ensuring the fishers' economic future.

#### **4.5 EM and surveillance perspectives**

The Danish Directorate for Fisheries has made a first assessment on whether some of the current fisheries management rules could be deleted or be changed if a fishery management system was based on "fully documented fishery". A first assessment on the strengths and weaknesses of the current implementation of the electronic monitoring experimental system and whether it could be used for fisheries compliance purposes was also conducted. The comments that follow are therefore initial opinions and comments and may not be regarded as the Danish Directorate of Fisheries official position as a further more detailed assessment is required.

The system setup can both contribute to better and more reliable information on discards but also contribute to; 1) higher reliability regarding landings being counted against the quota in the relevant management areas; 2) that the permitted fishing effort (kW-days/days at sea) is respected; 3) that no "unauthorized" landings occur in port; 4) and to increase the efficiency of the control.

Generally it is assessed that the EM system would work optimally if combined with the use of an electronic logbook. A prerequisite for optimal use is a camera setting that includes image recordings of the

whole working deck including the unloading hatch area and that the system remains operating during docking and unloading.

Implementation of a fully documented fishery management system could probably replace rules such as the ones on departure/ arrival in port and entering/departure of fishing area. Similarly, the system could negate the requirement for the present in port unload monitoring. However, there would need to be a clear demonstration that the hardware is of high quality and that the fishers are responsible in ensuring the systems are fully functional to allow the relaxation of those rules.

Additionally, a full documentation of all catches would potentially make the effort limitation schemes and rules redundant.

The system might be used in conjunction with the E-logbook that is recorded on a haul by haul basis with both the retained and discarded part of the catch. With the estimates of weight by species recorded linked to a functioning VMS it is possible that the prohibition on fishing in various regulation areas and the national requirements on management area shift reporting could be relaxed for participating fishers.

The roles of full documentation ensure that all catches are accounted for by weighing all discards and by ensuring that no other amount disappears before the catch is landed and weighed. Registration of the onboard catch weight – other than the amount of cod discarded has not taken place during this trial.

Specific present EU rules that might be relaxed for participants include:

Council Regulation no. 1098/2007 (Article 13, 16 and 17). Council Regulation no. 43/2009 TAC-quota, annex IIA, art. 13. Council Regulation no. 676/2007, art. 10. National Regulation no. 1359 from 19. December 2008 § 22.

If all the present regulations are examined more thoroughly there are probably more provisions that can be eliminated or relaxed in the license conditions for fully documented fishery participants.

## 4.6 Cost issues

Estimated costs for various tasks during this project can be presented as follows:

### Installation costs:

EM system:	app. € 5,500.-
Installment onboard per vessel (2 man days per vessel):	app. € 1,200.-
Consumables, blacksmith and other items per vessel:	app. € 1,500.-
<b>Total</b>	<b>app. € 8,200.-</b>

### Running costs for 300 days at sea and 500 hauls per year:

Maintenance of the system per vessel per year:	app. € 500.-
Exchange of hard drives per vessel per year:	app. € 1,000.-
Analysis of sensor data per vessel per year:	app. € 2,000.-
Analysis of images per vessel per year:	app. € 5,500.-
<b>Total</b>	<b>app. € 9,000.-</b>

It is obvious that with more experienced and more fully trained staff then sensor data analysis and imagery analysis costs are reduced. Furthermore, the more automation at the software level the lower the costs. It should also be evaluated whether all or just a subset of trips/events randomly selected would be sufficient for compliance purposes. A 10% audit or sampling level has shown significant accuracy with these systems in the British Columbia groundfish fishery in Canada (Stanley *et al.* 2009).

## 5 CONCLUSIONS AND RECOMMENDATIONS

The EM systems used during this trial has worked incredibly well and only minor technical problems have been encountered. In summary data from more than 16,900 hours at sea time was collected with a data loss of less than 2 % which confirms the system's reliability.

The costs for verifying a vessels fishery using EM is significantly less than obtaining the same information by using human observers onboard. Results from this study have shown that in most cases less than one hour data analysis and image viewing time would be required for verifying one fishing event and the associated catch handling activities. It should be noted though that if biological information (length frequency data, sex and maturity state) are required it has to be carried out either by the fishers or by an observer.

The analysis of the data collected by the sensors (GPS, hydraulic pressure and rotation of the winches) show that determination of where and when a fishing event takes place can be made with a high degree of accuracy. In addition by viewing the images it can be determined whether the fisher actually is fishing or just cleaning the net. Therefore, area misreporting of catches can be eliminated.

By viewing images from the catch handling onboard, an estimate of the total catch amount and the species distribution can be made. The focal point for this project has been discards of cod. Experience gained in the trial has shown that the estimate of discards of cod by viewing the images can be made with significant accuracy, especially if the vessel has a sorting conveyor belt where the discarded fish pass the discard chute individually. If large amounts of discards occur the accuracy of the estimate of the discard amounts decreases unless specific catch handling protocols are followed by fishers.

Adoption of electronic monitoring as a part of a fully documented fishery will probably require that the individual fisher participate on a voluntary basis. Voluntary participation would best ensure acceptance of legitimacy of the documentation and in having the fisher accept the "burden of proof", thus ensuring a more comfortable legal position in cases of infringement.

The level of incentive for the vessel strongly affects the operational integrity of EM as a reliable tool for documenting catches. Furthermore, the implementation and running of the system needs close cooperation between the industry and the authorities to ensure maximum data security.

The experiences obtained during this trial have shown that an electronic monitoring system can be applied on almost all types of pelagic fishing vessels and those fishing for sandeel, sprat, blue whiting and Norway pout along with newer demersal fishing vessels to give a 100% documentation of the fishing activities. In the case of other vessels it may be necessary to make changes in the vessel deck setup and working interior in order to ensure effective monitoring.

In general, responses from the skippers and crew participating in the project have been very positive. Both skippers and crew have been very cooperative and diligent in getting the best possible quality of

data. The cooperation between the fishers and scientists during this trial has demonstrated that the fishers become more aware of where and when large amount of small cod have been caught. In such instances, fishers respond by changing fishing grounds, or making changes to gear or mesh size. Furthermore, there has been a positive reaction from the fishers as they have shown an increased awareness of their fishing patterns. The idea of giving the fishers an incentive, by way of a quota increase, in return for assuming more responsibility to ensure that all catches retained and discarded are counted on their quota, is seen as a way forward toward sustainable fishing.

The cooperation and talks with the participating fishers has shown that the fishers' enthusiasm was not simply limited to the potential for increased catch quotas but also includes a strong wish to ensure robust biological data is available for research and management advice. Some of the fishers have appreciated the potential of full documentation in relation to market requirements, and they have pointed to the systems strong advantages compared to the MSC certification scheme.

Based on the results and experiences Electronic Monitoring systems can be implemented as a new tool in the management of fisheries and promote the development of sustainable fisheries management.

## 6 REFERENCES

McElderry, H. 2008. At-Sea Observing Using Video-Based Electronic Monitoring. Report prepared for the Electronic Monitoring Workshop held by The North Pacific Fishery Management Council, The National Marine Fisheries Service and The North Pacific Research Board, July 2008.

McElderry, H, R. Reidy, D. Pahti, 2006. A Pilot Study to Evaluate the Use of Electronic Monitoring on a Bering Sea Groundfish Factory Trawler. Unpublished report prepared for the International Pacific Halibut Commission by Archipelago Marine Research Ltd., Victoria BC, Canada.

McElderry, H., A. Crumpacker, R. Wright and D. McCullough. 2005. Electronic Monitoring for the 2005 U. S. Shore-based Pacific Hake Fishery--A Pilot Study. Unpublished report prepared for the National Marine Fisheries Service, Northwest Fisheries Science Center, National Oceanic & Atmospheric Administration, Department of Commerce by Archipelago Marine Research Ltd., Victoria BC, Canada.

Stanley, R., N. Olsen, A. Fedoruk. 2009. Independent validation of the accuracy of 1 yelloweye rockfish (*Sebastes ruberrimus*) catch estimates from the Canadian Groundfish Integration Pilot Project. *In press*. Marine and Coastal Fisheries: Dynamics, Management, and Ecosystem.

## 7 ACKNOWLEDGEMENT

The Danish Ministry for Food, Agriculture and Fisheries, Danish Food Industry Agency funded this project.

We are grateful for the co-operation and support of vessel owners, skippers and crews onboard the Danish fishing vessels HM 555 "Kingfisher", S 84 Frk. Nielsen, H 79 "Tiki" and ND 399 "Meonia", HM 423 "Fru Middelboe", S 530 "Yokotani" and ND 176 "Søstrene" who carried EM equipment aboard their vessels, demonstrated interest and significant willingness for providing feedback throughout the whole project period.

This project has been conducted without major difficulties thanks to Archipelago Marine Research Ltd. and the professionalism provided by Howard McElderry, Morgan Dyas, Maria Jose Pria, Dale McCullough and their colleagues.

Several DTU Aqua staff participated in this project including: Reinhardt Jensen, Gert Holst, Peter Vingaard Larsen, Tommy Nielsen, Frederik Mathiassen, Lene Hansen, Rikke Reisner Hansen, Bo Hansen and Kirsten Birch Håkansson

Thanks to Bob Stanley, Australian Fisheries Management Authority and Howard McElderry, Archipelago for critical review and proofreading of the report.

## 8 APPENDIXES

### Appendix 1

#### Overview of the EM System

The EM system supplied by Archipelago operated on 110 AC voltage to record imagery and sensor data during each fishing trip. The software was set to automatically activate image recording based on preset sensor indicators (e.g. net and longline retrieval). The EM system automatically restarted and resumed program functions following power interruption. The system components are schematically presented in Figure 1 and described in the following sections.

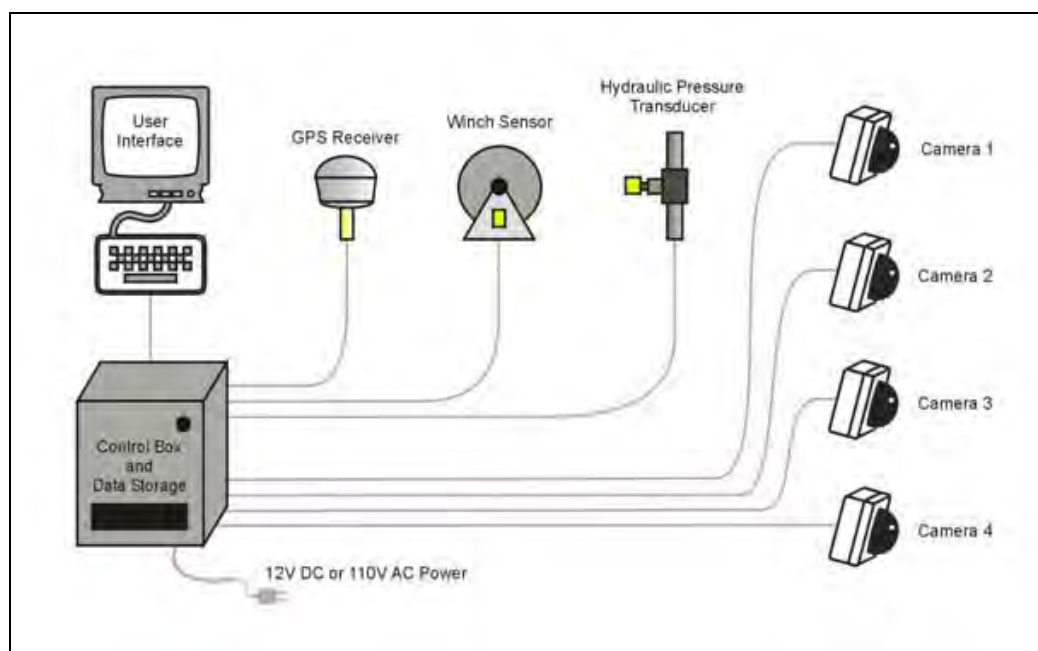

**Figure 1.** Schematic diagram of the electronic monitoring system, which can record video data from up to four cameras per vessel.

#### Control Box

The heart of Archipelago's electronic monitoring system was a metal tamper-proof control box (approx. 30x20x19 cm.) that housed the digital data logger and video computer circuitry (Figure 2). The control box was mounted in the wheelhouse and continuously powered with 24 volts DC or 220 volts AC respectively.



**Figure 2.** An EM control box in a vessel's wheelhouse.

### Video and Digital Data Storage

Each EM system had a pair of 500 GB computer hard drives that were used for video data collection. Drives could be swapped on the vessel to allow review to take place on shore. Along with the video imagery, GPS and sensor data were also recorded on the video hard drive.

### CCTV Cameras

Closed circuit television (CCTV) cameras were chosen for installation on these fishing vessels (Figure 3). The camera design has proven reliable in extreme environmental conditions for long-term deployments on vessels in other fisheries. A choice of lenses from fisheye to telephoto for optimally adjust the field of view and image resolution on each vessel.



**Figure 3.** Photograph of an installed CCTV camera on a vessel encased in a cast aluminum armored dome.

The color cameras had 640 x 480 lines of resolution and low light capability (0.6 lux). The output signal was standard composite video delivered to the digital video recorder by an RG59 coaxial cable. Twelve volt DC power was supplied to the camera via paired 18 gauge wires packaged within a single sheath with the coaxial cable.



## GPS Receiver

An independent Garmin 17N GPS receiver was installed with each EM system. (Figure 4). The Garmin GPS receiver is a 12 channel parallel receiver, meaning it can track up to 12 GPS satellites at once while using four satellites that have the best spatial geometry to develop the highest quality positional fix.



**Figure 4.** GPS receiver installed in the rigging of a gillnet vessel away from other antennae and radars (left), and a close up photograph of the mounted GPS.

The GPS time code delivered with the Garmin positional data is accurate to within two seconds of the Universal Time Code (UTC). Archipelago's EM software uses the GPS time to chronologically stamp data records and to update and correct the real time clock on the data-logging computer. When 12 volts DC is applied to the GPS it delivers a digital data stream to the data-logging computer that provides an accurate time base as well as vessel position, speed, heading and positional error. The EM system records the latitude and longitude in degrees and minutes to three decimal places thereby providing a theoretical resolution of 1.85 meters (1 minute of latitude = 1,852 meters). Speed is recorded in nautical miles per hour (knots) to one decimal place and heading to the nearest degree.

## Hydraulic Pressure Transducer

The sensor has a zero to 2500 psi range, high enough for most small vessel systems, and a 15,000 psi burst rating. The sensor is fitted into a quarter inch pipe thread gauge port or tee fitting on the pressure side of the hauler circuit.



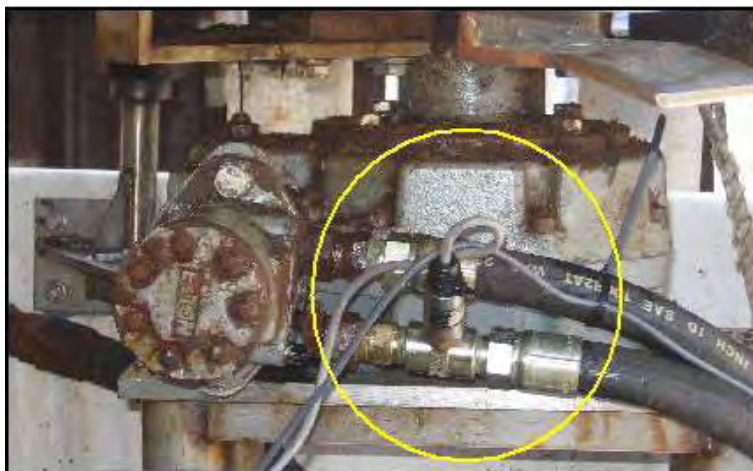

**Figure 6** A hydraulic pressure sensor installed on the supply line of a vessel for monitoring power at the winch and triggering video recording.

An increase in system pressure signals the start of fishing operations such as trawl shot of a net set. When pressure readings exceed a threshold the control box software turns the digital video recorder on to initiate video data collection.

### **Drum Rotation Sensor**

The waterproof sensors were usually mounted in protected locations and a reflector was mounted on a rotational component of each hauler.

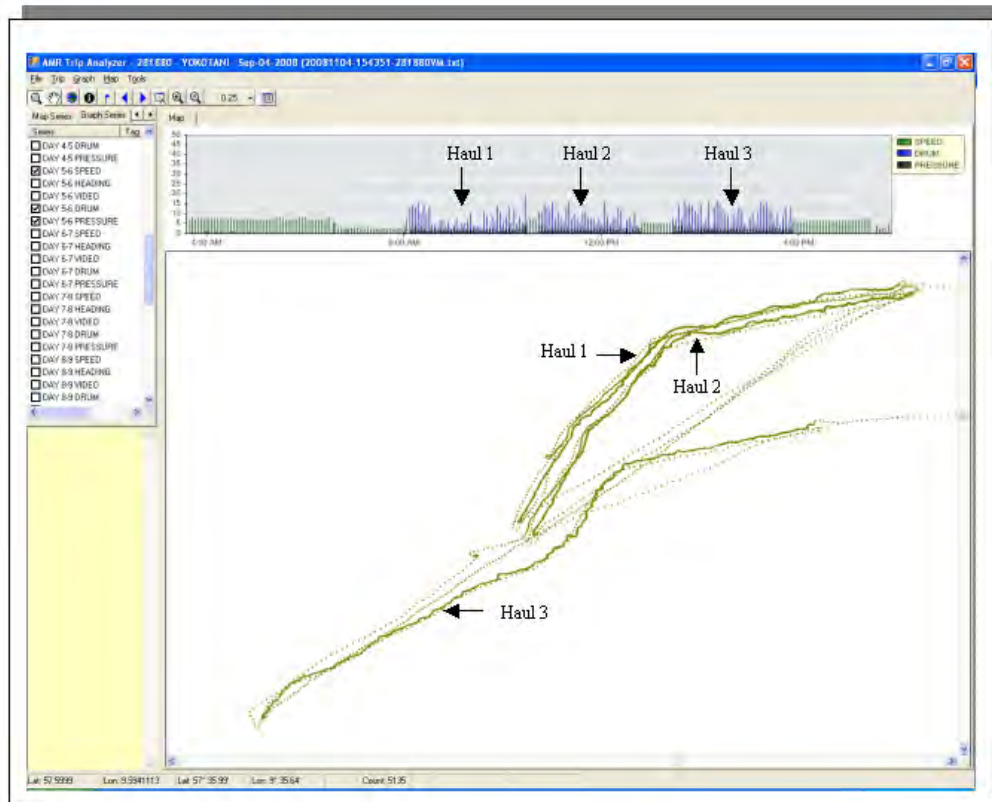

**Figure 7** An installed photoelectric drum rotation sensor that tracked vessel setting and hauling events in the sensor data, and functioned as a secondary trigger for video recording.

## Appendix 2

The following are examples of how fishing activity have been detected by using sensor data.

### YOKOTANI



### Gear Type

Gillnet vessel - A submerged net that was anchored at each end. The net was allowed to soak and then hauled on board and the catch was processed.

### Sets – Not data entered

Sometimes there was a short spike of pressure at the beginning of the set.

No drum rotation during event.

No pressure during event.

Average speed may be 6.5 to 7.5 knots.

### Haul

Speed generally < 1.5 knots.

Inconsistent slow drum rotation less than 10.

Continuous pressure between 125 and 175 psi.

## FRU MIDDELBOE

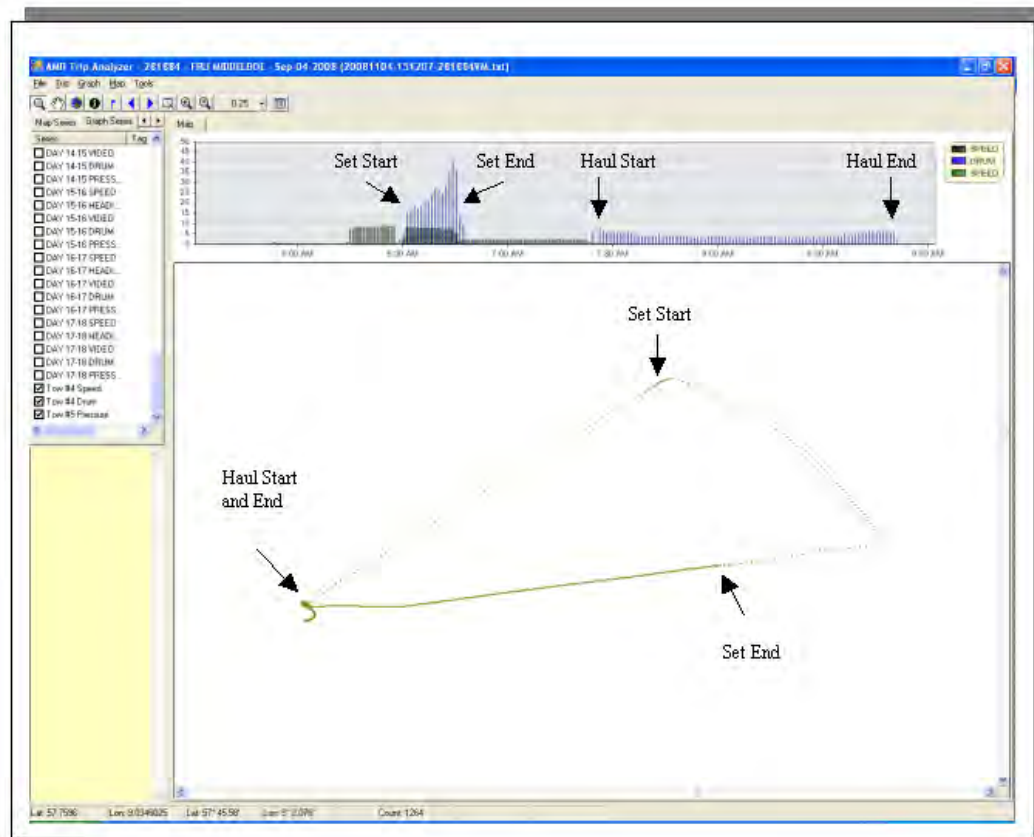

### Gear Type

Danish Seine vessel - A seine net is deployed by first putting out one drag line, then one net wing, the body of the net, one net wing and finally a second drag line. The drag lines are then hauled from both ends at the same time.

### Sets

From the point of origin, the vessel steams away at 8-9 knots.

When the vessel corners they begin to deploy the net with drum rotation of 25-35 at a speed of about 8 knots. Midpoint was entered where the vessel turns back towards the point of origin and continues to set net for a short period.

At the end of the drum rotation the vessel slows to 2-3 knots and returns to the point of origin.

### Haul

At origin the vessel is stationary while hauling the net with drum less than 10 and pressure around 200.

FRK NIELSEN

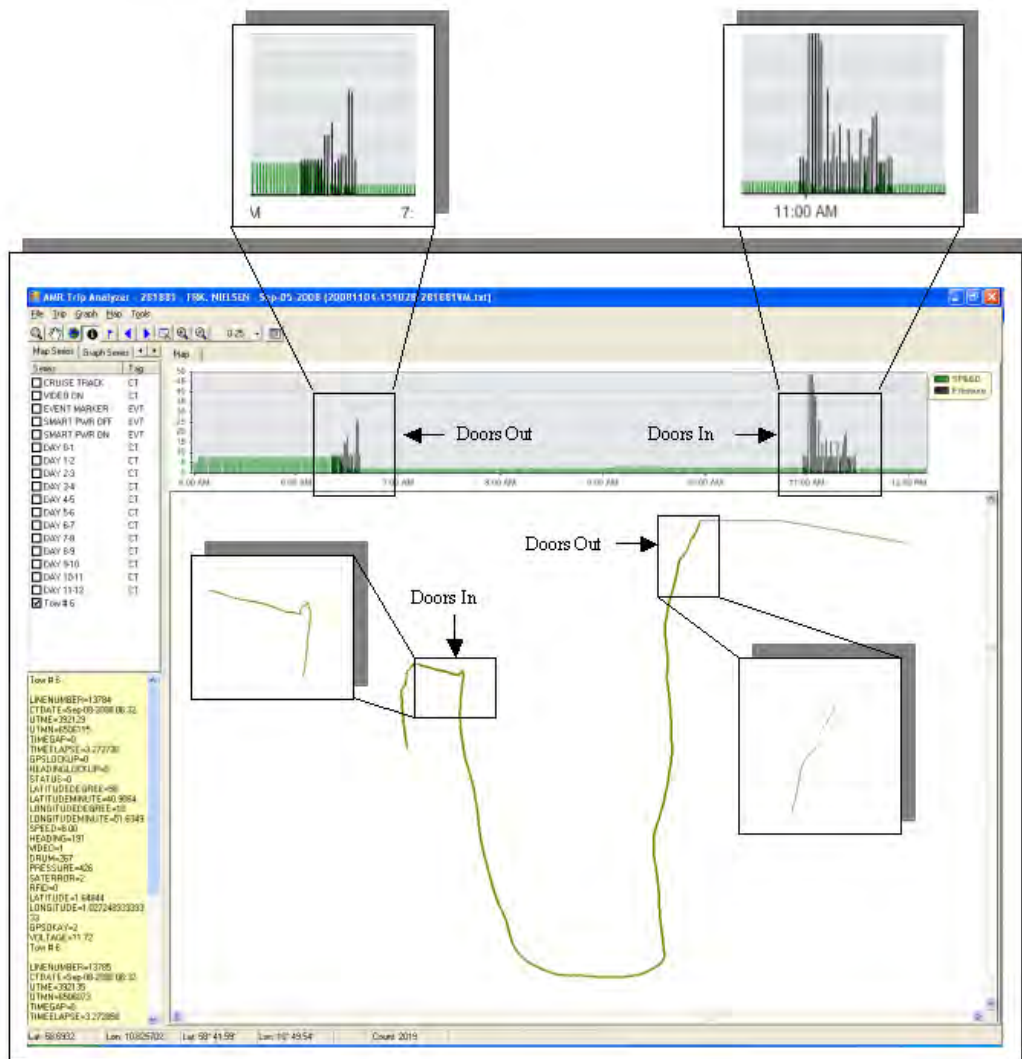

### Gear Type

Trawl vessel - A net is deployed and towed behind vessel. It is hauled back and the net is brought on board so the catch can be processed.

### Doors Out

There was no drum sensor data available and approximately 15 minutes of pressure ~400 psi with a short spike up to ~1200 at the end.

### Towing

A constant speed between 2 and 3 knots for an average of 5 hours

### Doors In

There was no drum sensor data available and approximately 10 minutes of pressure ~2400 psi which eventually drops down to ~400.

Followed by a period of very low speed (<1.5 knots) while catch is processed

## KINGFISHER

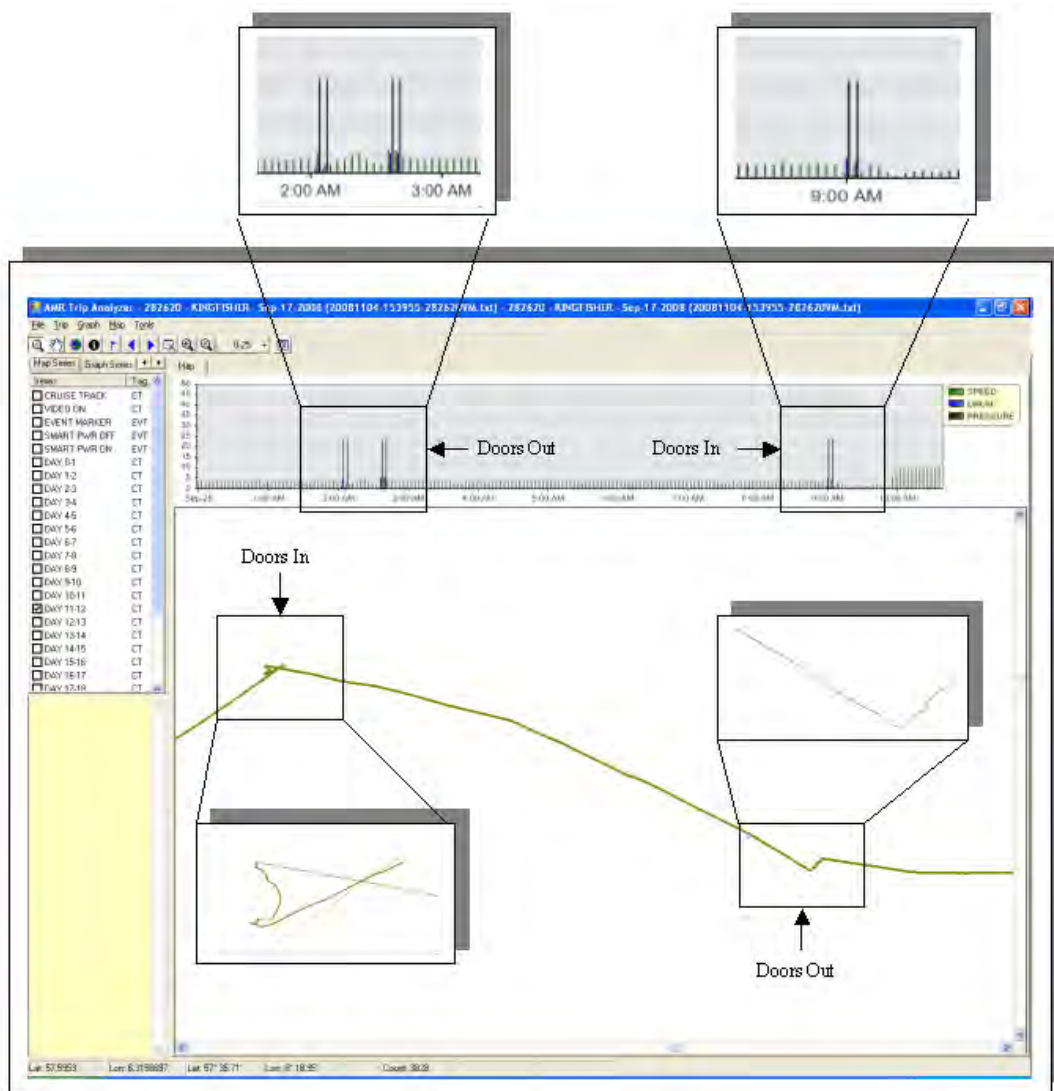

### Gear Type

Trawl vessel - A net is deployed and towed behind vessel. It is hauled back and the net is brought on board for catch processing.

### Doors Out

Short (4 minute) burst of drum ~6 and pressure ~1100 psi.

### Towing

A constant speed about 3.5 knots for an average of 5 to 7 hours.

### Doors In

Short (4 minute) burst of drum ~6 and pressure ~1100 psi.

Vessel turns back slightly at the end of each tow.

Followed by a period of very low speed (<1.5 knots) while catch is processed.



## MEONIA

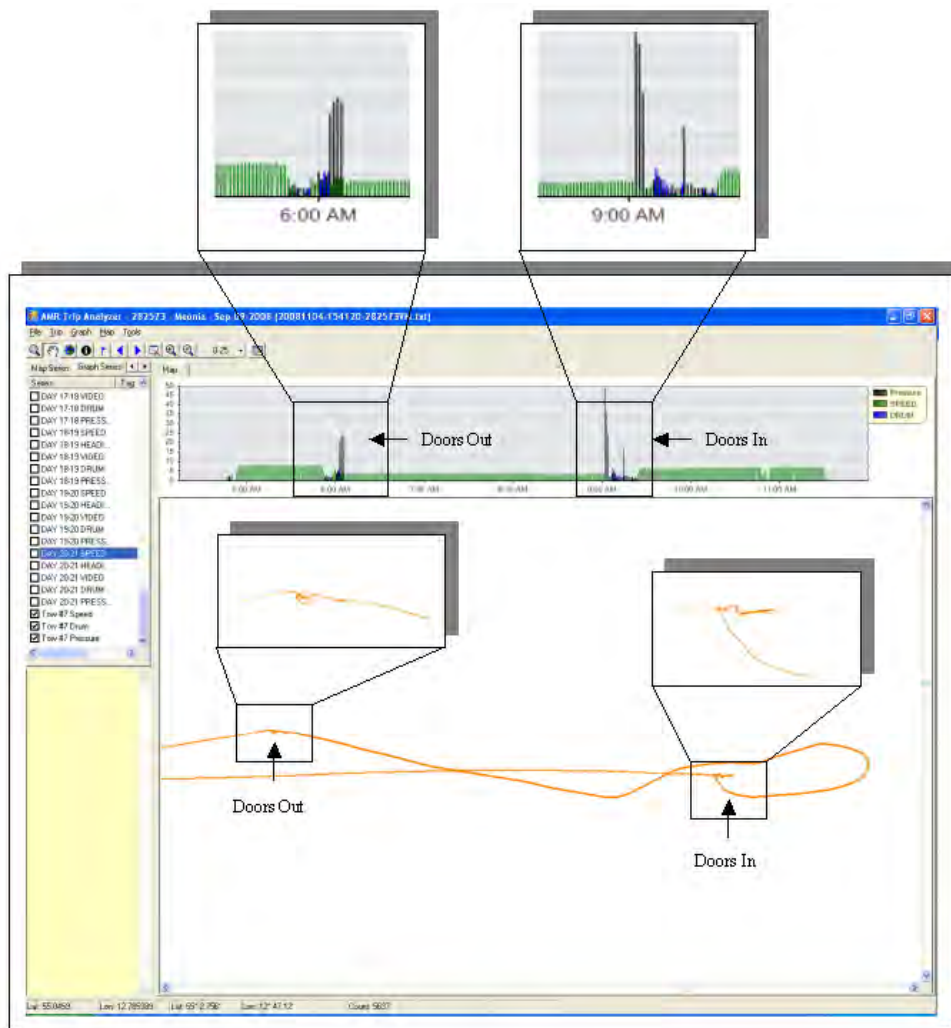

### Gear Type

Trawl vessel - A net is deployed and towed behind vessel. It is hauled back and the net is brought on board for catch processing.

### Doors Out

3 minutes of drum around 6-7 followed by 4 minutes of pressure greater than 1000 psi. Few lines with drum rotation at the end of the pressure.

### Towing

A constant speed about 4 knots for an average of 4 hours.

### Doors In

4 minutes of high pressure followed by pressure with drum rotation less than 6. Followed by a period of very low speed (<1 knot) while catch is processed

# TIKI

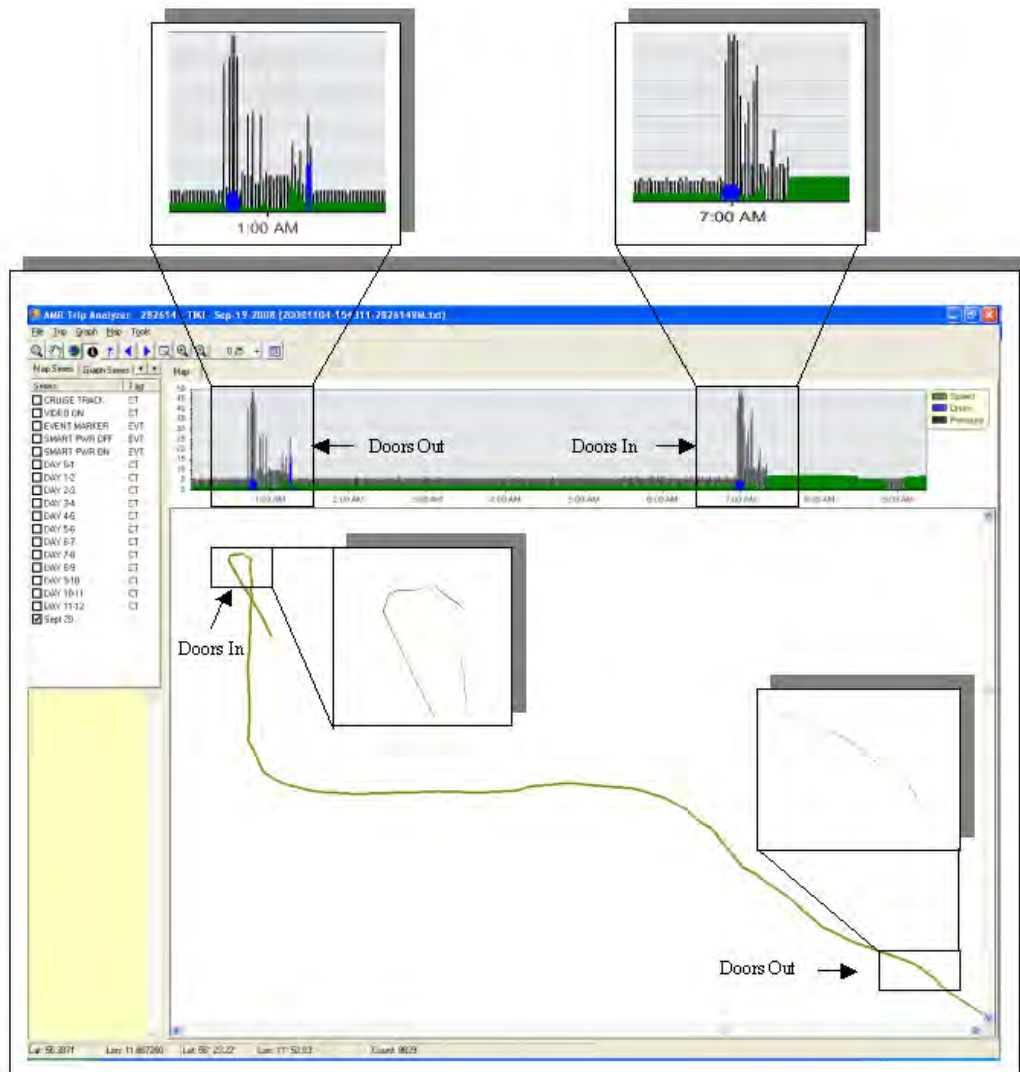

## Gear Type

Trawl vessel - A net is deployed and towed behind vessel. It is hauled back and the net is brought on board for catch processing.

## Doors Out

Short burst of drum between 10 and 15 with a pressure spike ~1300 psi for 2 minutes.

## Towing

A constant speed between 2.5 and 3.0 knots for an average of 5 hours.

The report describes the results of the project "Fully Documented Fishery" .

The objectives of the one year pilot project were to evaluate whether the use of electronic monitoring could give a reliable documentation of fishing operations, catches, catch handling and discard patterns that could be used to verify the fishers' recordings of their fisheries. Furthermore, the reliability and functionality of the electronic monitoring system and to investigate whether a change from landing quotas to catch quotas could improve the sustainability of the fishery and improve the fishers economy.

The project was conducted by DTU Aqua and funded by The Danish Ministry of Food, Agriculture and Fisheries and the European Fisheries Fund.

DTU Aqua  
Danish Institute of Aquatic Resources  
Technical University of Denmark

Jægersborg Allé 1  
DK-2920 Charlottenlund  
Denmark  
Tel: + 45 33 96 33 00  
Fax: + 45 33 96 33 33

[www.aqua.dtu.dk](http://www.aqua.dtu.dk)